

REV.	DATE	ENR	CHG	APPD	DESCRIPTION
CONTRACTOR					
 (주)호원아이앤씨 HVM Instrument & Control Co., Ltd.					
PROJECT					
DRAWN	TITLE				
CHECKED	HV/LV PANEL				
APPROVED	SINGLE LINE DIAGRAM				
SCALE	DATE DRAWN	DATE REV.	SCALE		

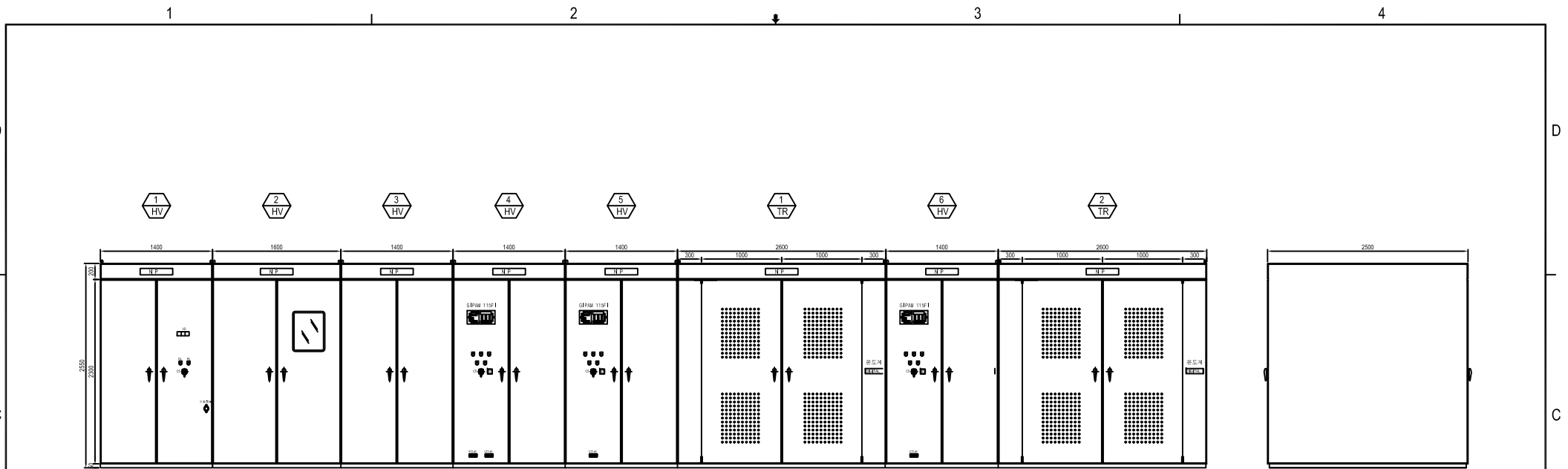

FRONT VIEW

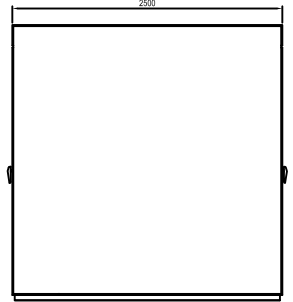

SIDE VIEW

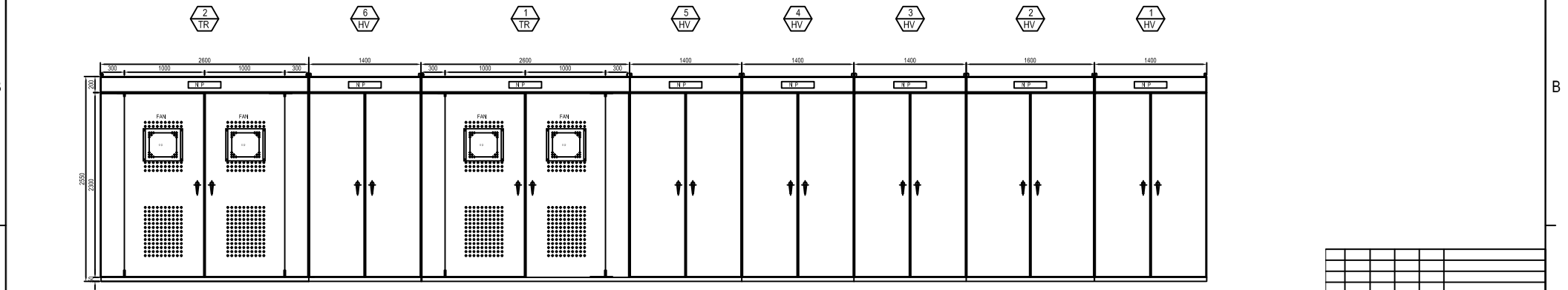

REAR VIEW

REV.	DATE	DRN	CHG	APPD	DESCRIPTION
DRAWN					
CHECKED					
APPROVED					
SCALE	DATE DRAWN	DATE DES.			
PROJECT					
 (주)호원아이앤씨 HWIN Instrument & Control Co., Ltd.					
CONTRACTOR					
PROJECT					
DRAWN		TITLE			
		HV/LV PANEL			
CHECKED		HV PANEL LAYOUT			
APPROVED					
SCALE	DATE DRAWN	DATE DES.			
100% CLASSIFICATION NO. CLIENT DRAWING NO.					

1

2

3

4

D

D

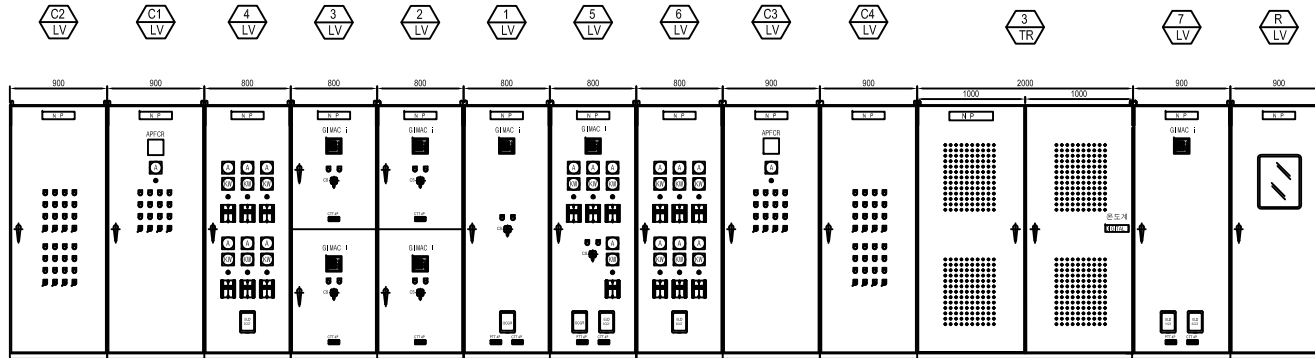

FRONT VIEW

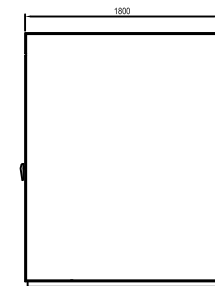

SIDE VIEW

C

C

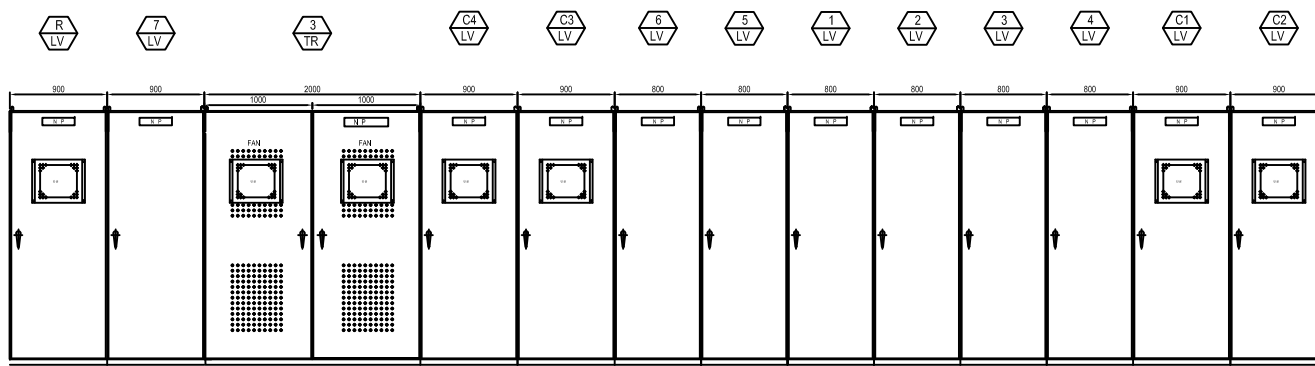

REAR VIEW

B

B

C2 LV C1 LV 4 LV 3 LV 2 LV 1 LV 5 LV 6 LV C3 LV C4 LV 3 TR 7 LV R LV

R LV 7 LV 3 TR C4 LV C3 LV 6 LV 5 LV 1 LV 2 LV 3 LV 4 LV C1 LV C2 LV

A

A

REV.	DATE	DRN	CHKD	APPR	DESCRIPTION
CLIENT					
CONTRACTOR					
 (주)호원아이앤씨 HWIN Instrument & Control Co., Ltd.					
PROJECT					
DESIGNER	TITLE				
DRAWN	HV/LV PANEL				
CHECKED	LV PANEL LAYOUT				
APPROVED					
SCALE	DATE DRAWN	DATE NO.			
NO.					
DESIGN CONSULTANT	CLIENT DRAWING NO.				

1

2

3

4

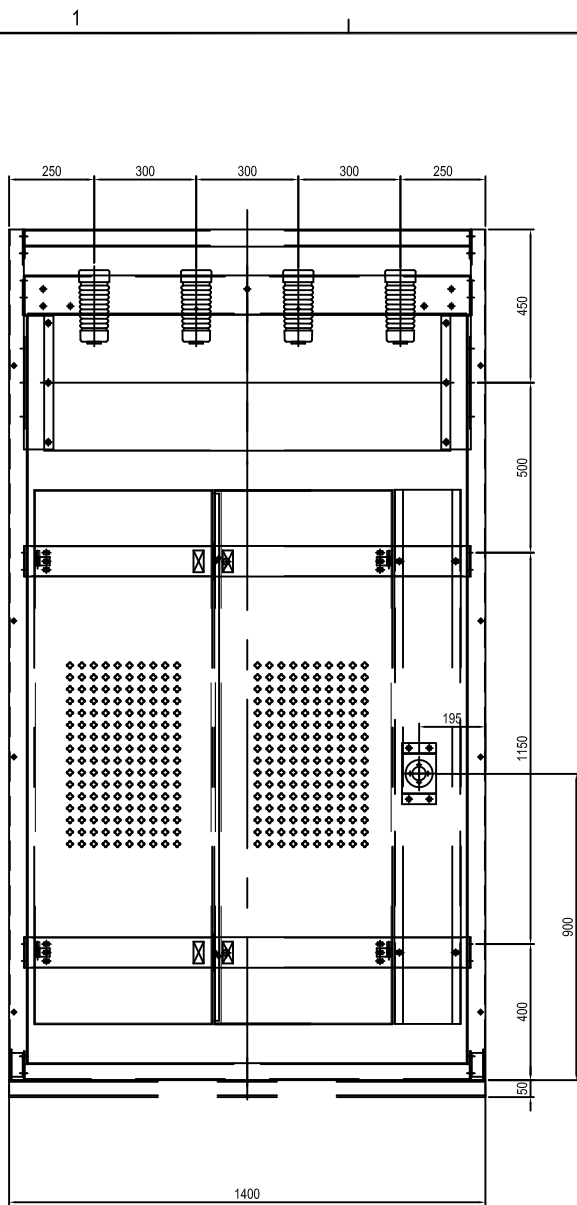

A3 (420 x 297 m/m)

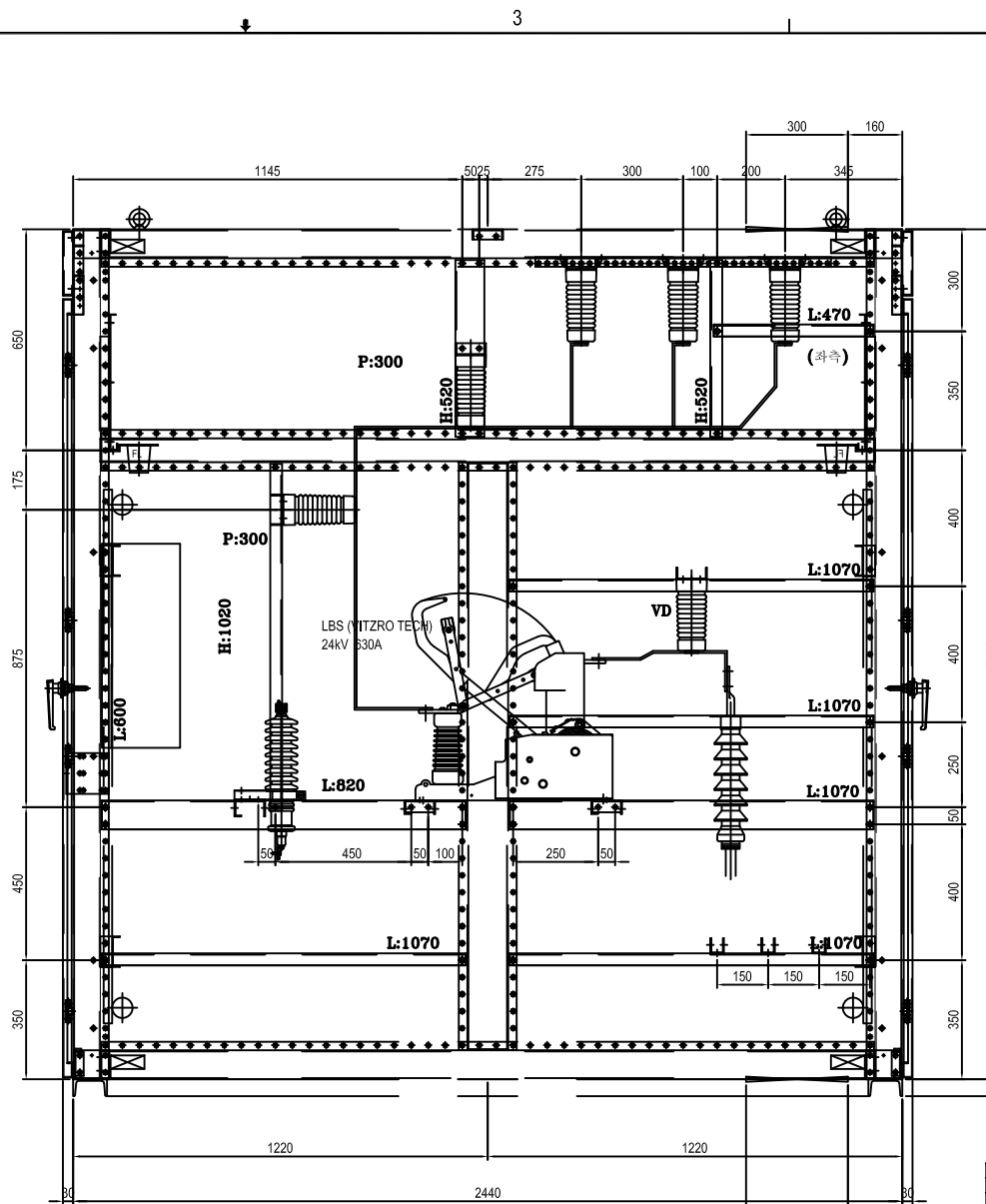

IN FRONT VIEW



IN SIDE VIEW

REV.	DATE	BY	CHKD	APPD	DESCRIPTION
CONTRACTOR					
 (주) 호원아이앤씨 HWIN Instrument & Control Co., Ltd.					
PROJECT					
TITLE					 
DRAWN HV/LV PANEL CHECKED HV-1 PANEL LAYOUT APPROVED					
SCALE	DATE DRAWN	DATE	DATE	DATE	DATE
NO.					
DESIGN CLASSIFICATION NO.					

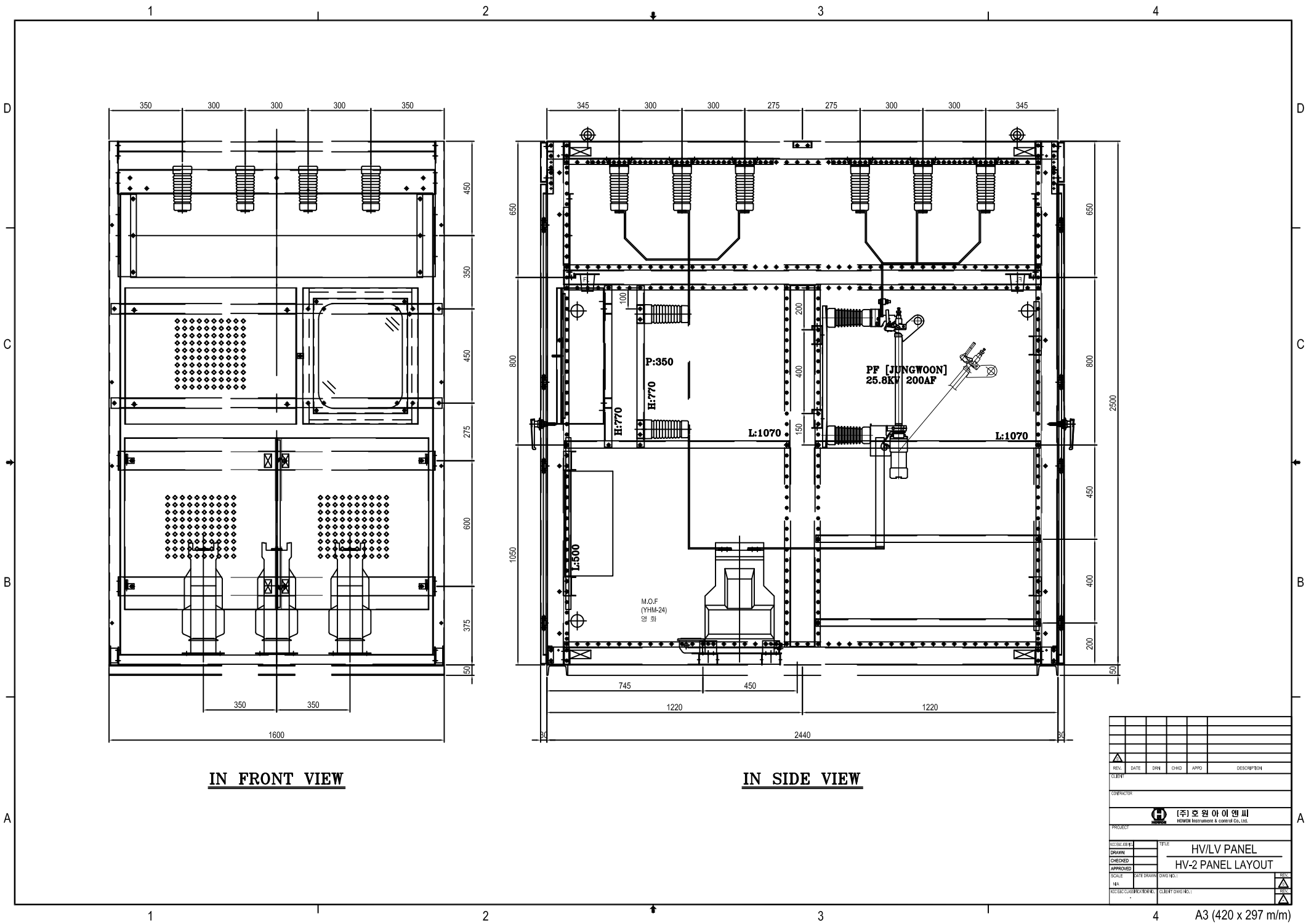

IN FRONT VIEW

IN SIDE VIEW

REV.	DATE	DRN	CHKD	APPD	DESCRIPTION
CLIENT					
CONTRACTOR					
PROJECT					
 (주)호원아이앤씨 JW Instrument & Control Co., Ltd.					
TITLE					REV.
DRAWN					1
CHECKED					
APPROVED					
SCALE	DATE DRAWN	DATE NO.			
NO.					
DESIGN/CONSULTANT NO.		CLEARING NO.			

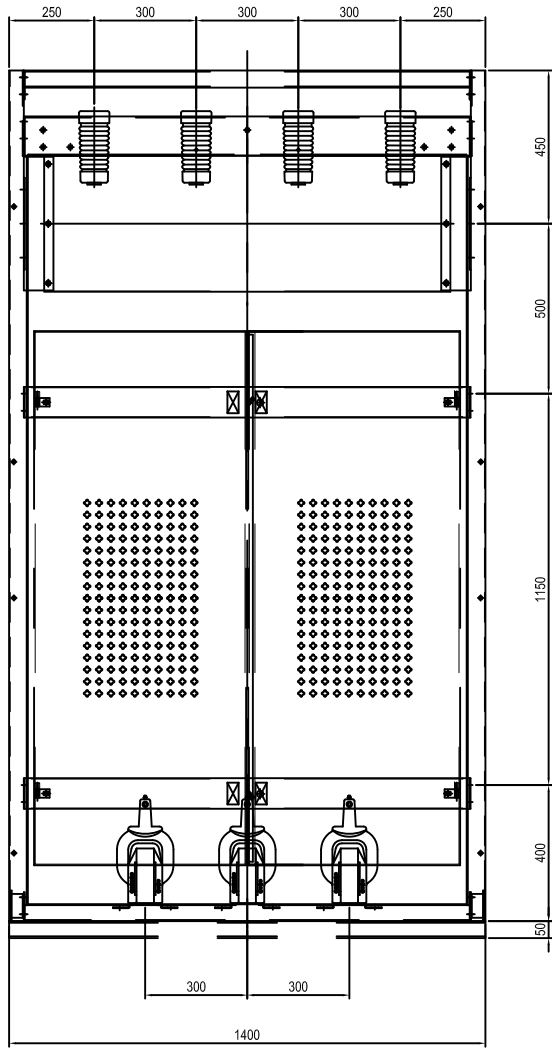

IN FRONT VIEW

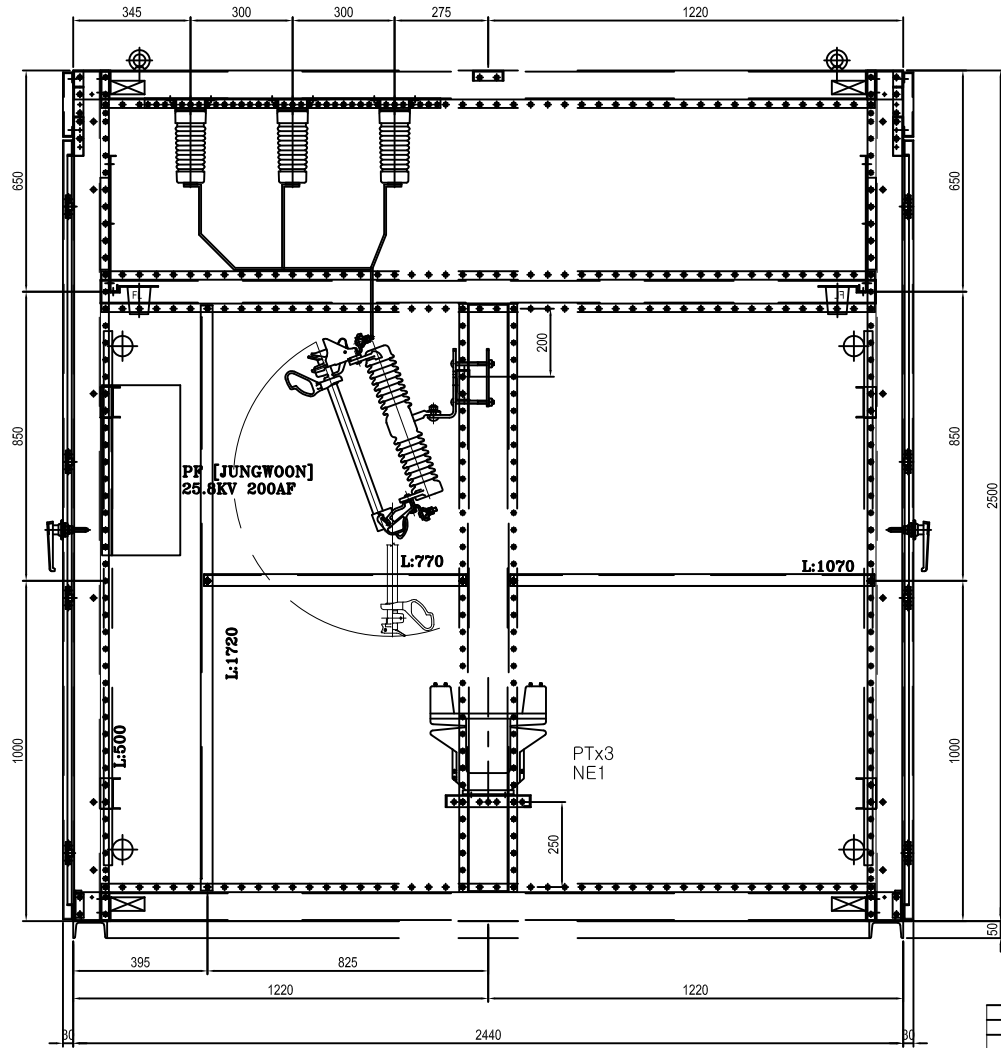

IN SIDE VIEW

REV.	DATE	BY	CHKD	APPD	DESCRIPTION
CLIENT					
CONTRACTOR					
PROJECT					
(주)호원아이앤씨 HWIN Instrument & Control Co., Ltd.					
TITLE					REV.
DRAWN					
CHECKED					
APPROVED					
SCALE	DATE DRAWN	DRAWING NO.		 	
DESIGN CONSULTANT				CLIENT DRAWING NO.	

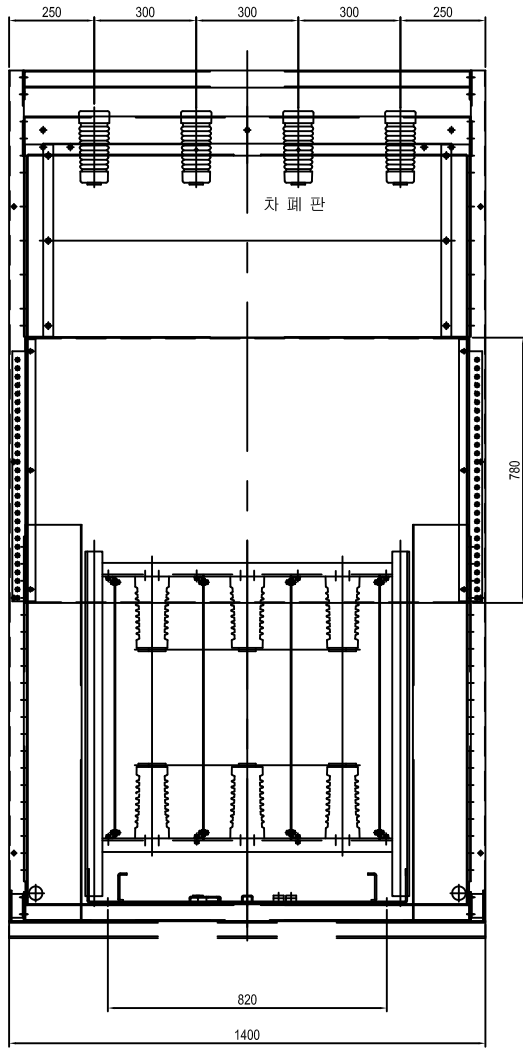

IN FRONT VIEW

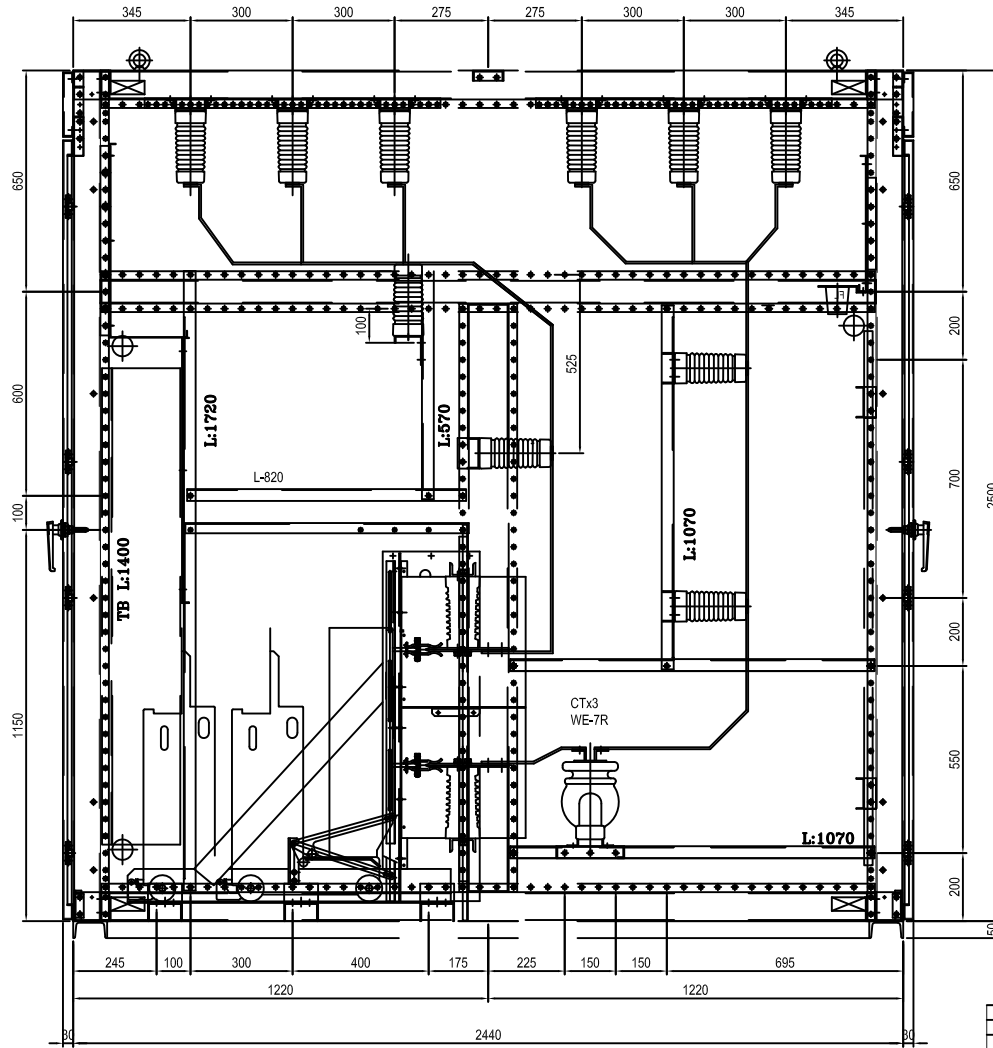

IN SIDE VIEW

REV.	DATE	BY	CHKD	APPD	DESCRIPTION
DRAWN					
CHECKED					
APPROVED					
SCALE	DATE DRAWN	DATE	DATE	DATE	DATE
PROJECT					 (주)호원아이앤씨 HWIN Instrument & Control Co., Ltd.
CONTRACTOR					
TITLE					HV/LV PANEL HV-4 PANEL LAYOUT
DRAWN					
CHECKED					
APPROVED					
SCALE					
DATE DRAWN					
DATE					
DATE					

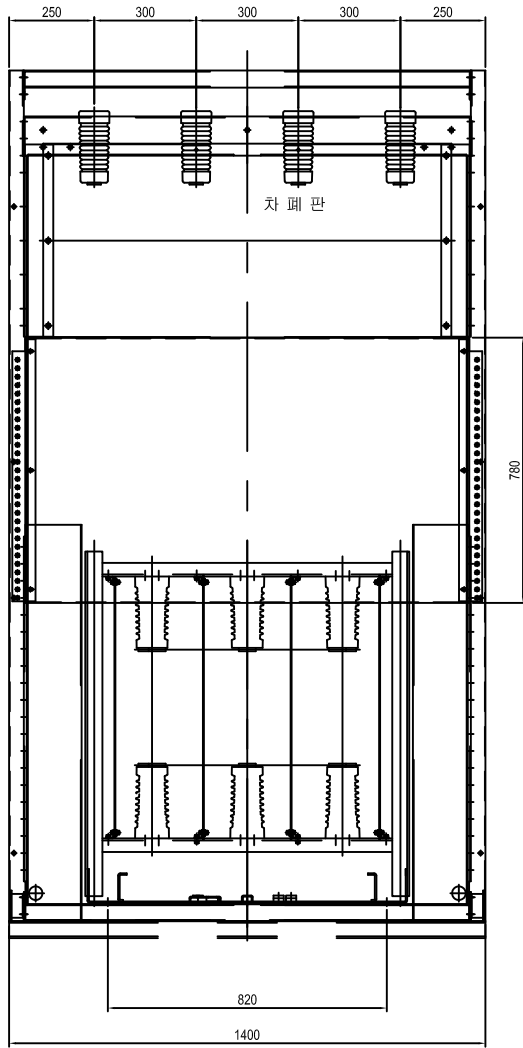

IN FRONT VIEW

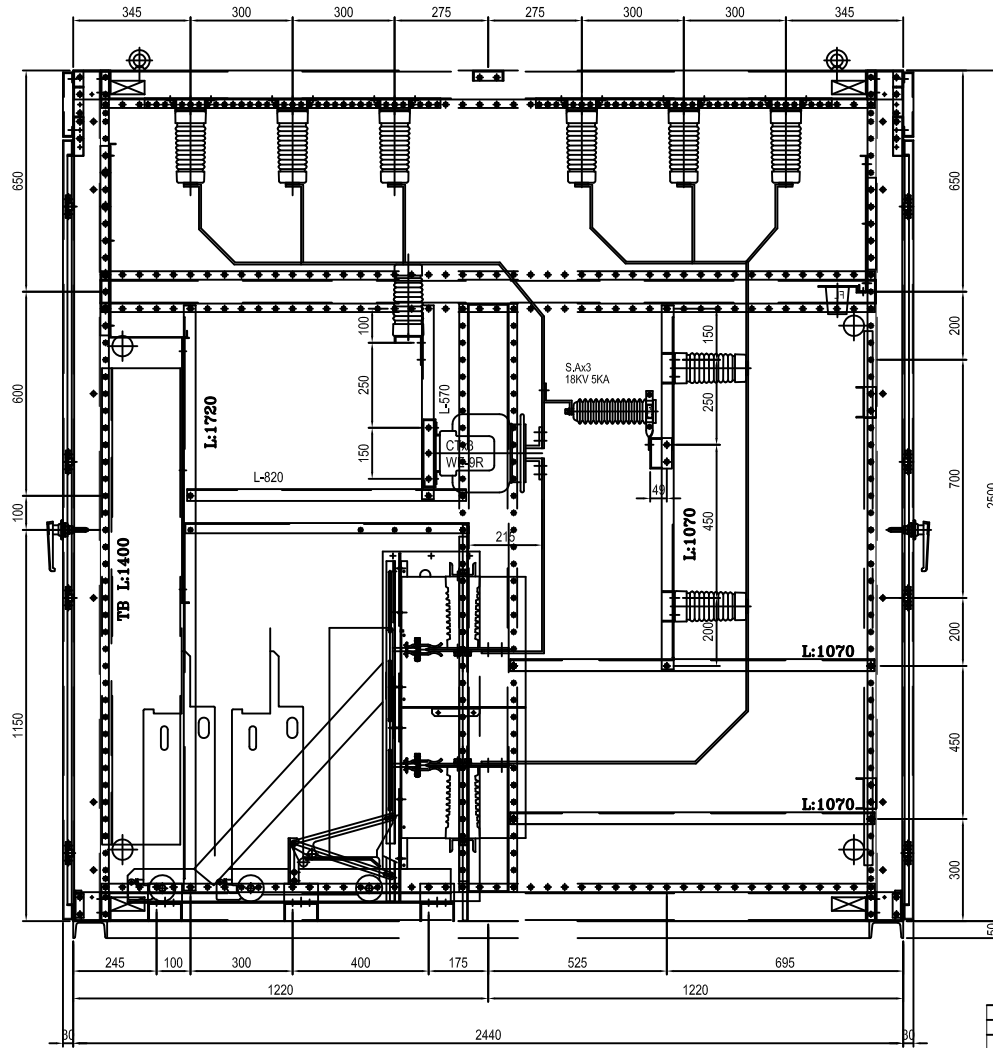

IN SIDE VIEW

REV.	DATE	DRN	CHKD	APPR	DESCRIPTION
DRAWN					
CHECKED					
APPROVED					
SCALE	DATE DRAWN	DATE NO.			
PROJECT					
 (주)오원아이엔씨 HWIN Instrument & Control Co., Ltd.					
TITLE					
HV/LV PANEL					
HV-5 PANEL LAYOUT					

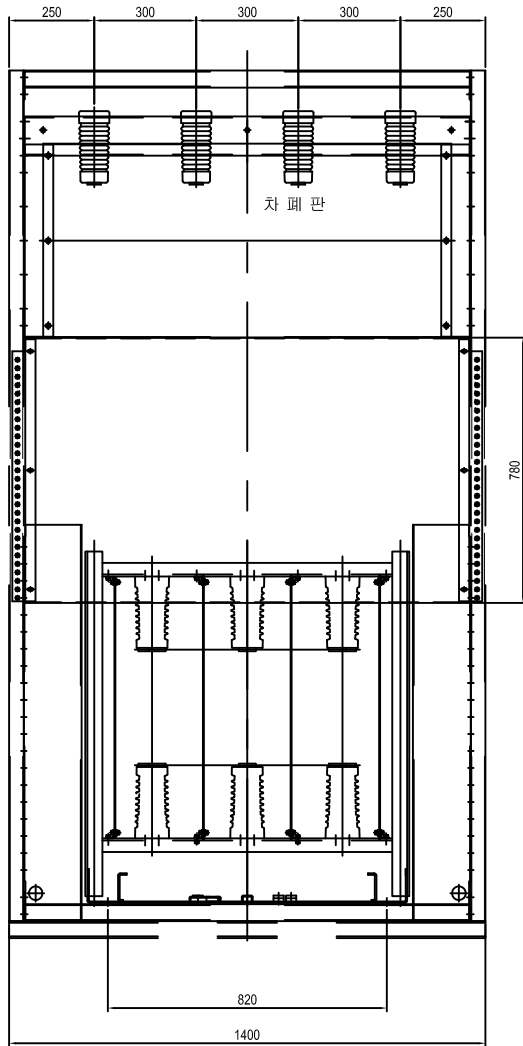

IN FRONT VIEW

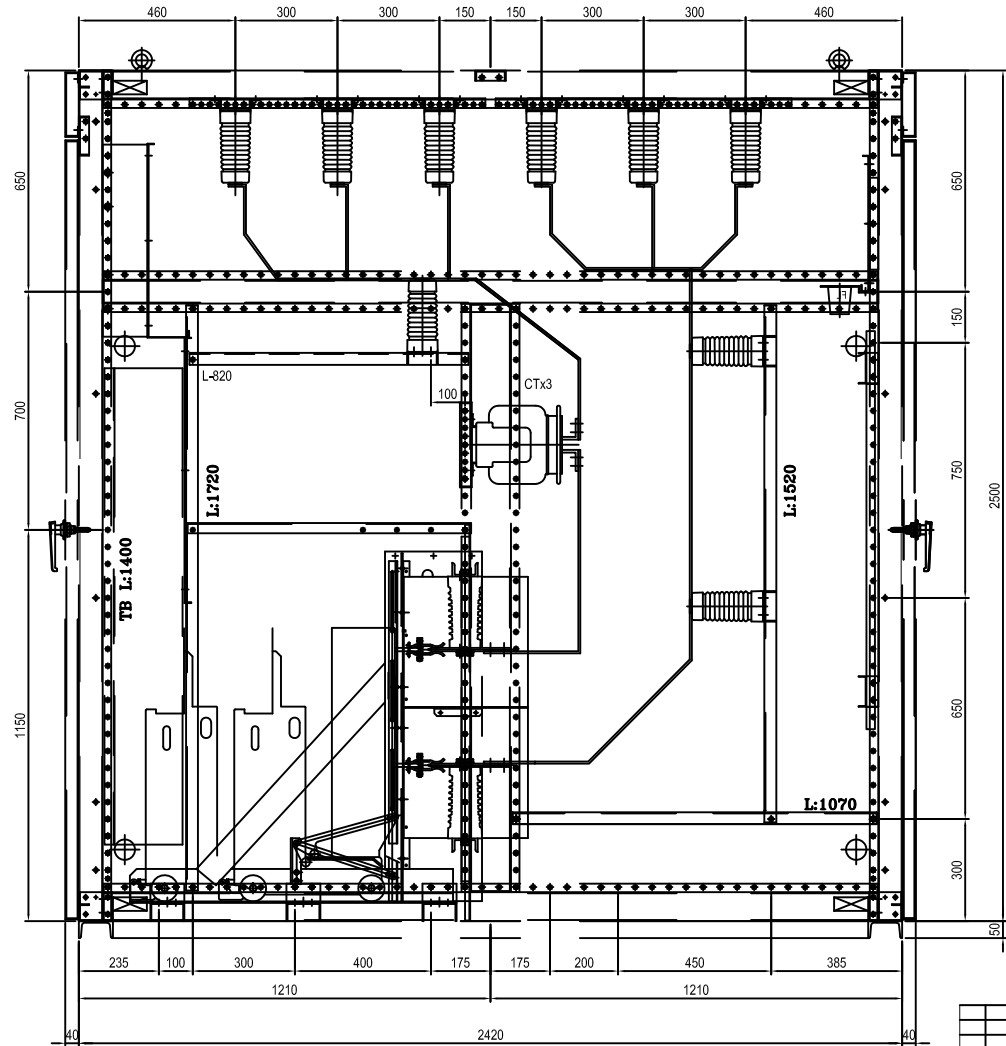

IN SIDE VIEW

REV.	DATE	DRN	CHG	APPD	DESCRIPTION
DRAWN					
CHECKED					
APPROVED					
SCALE	DATE DRAWN	DATE	NO.	DATE	NO.
PROJECT					 (주)호원아이앤씨 HWIN Instrument & Control Co., Ltd.
CONTRACTOR					
TITLE					HV/LV PANEL HV-6 PANEL LAYOUT
DESCRIPTION					

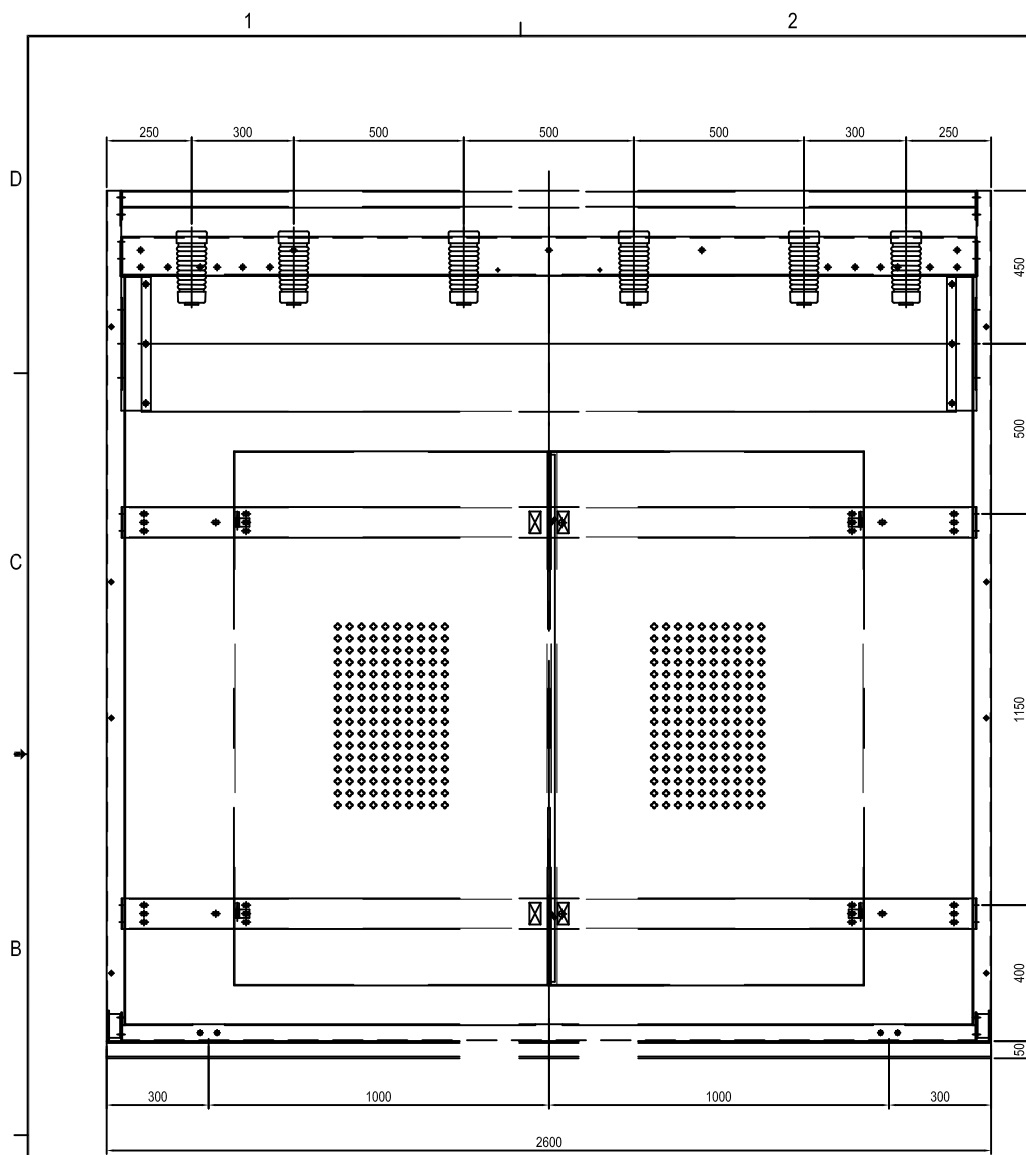

IN FRONT VIEW

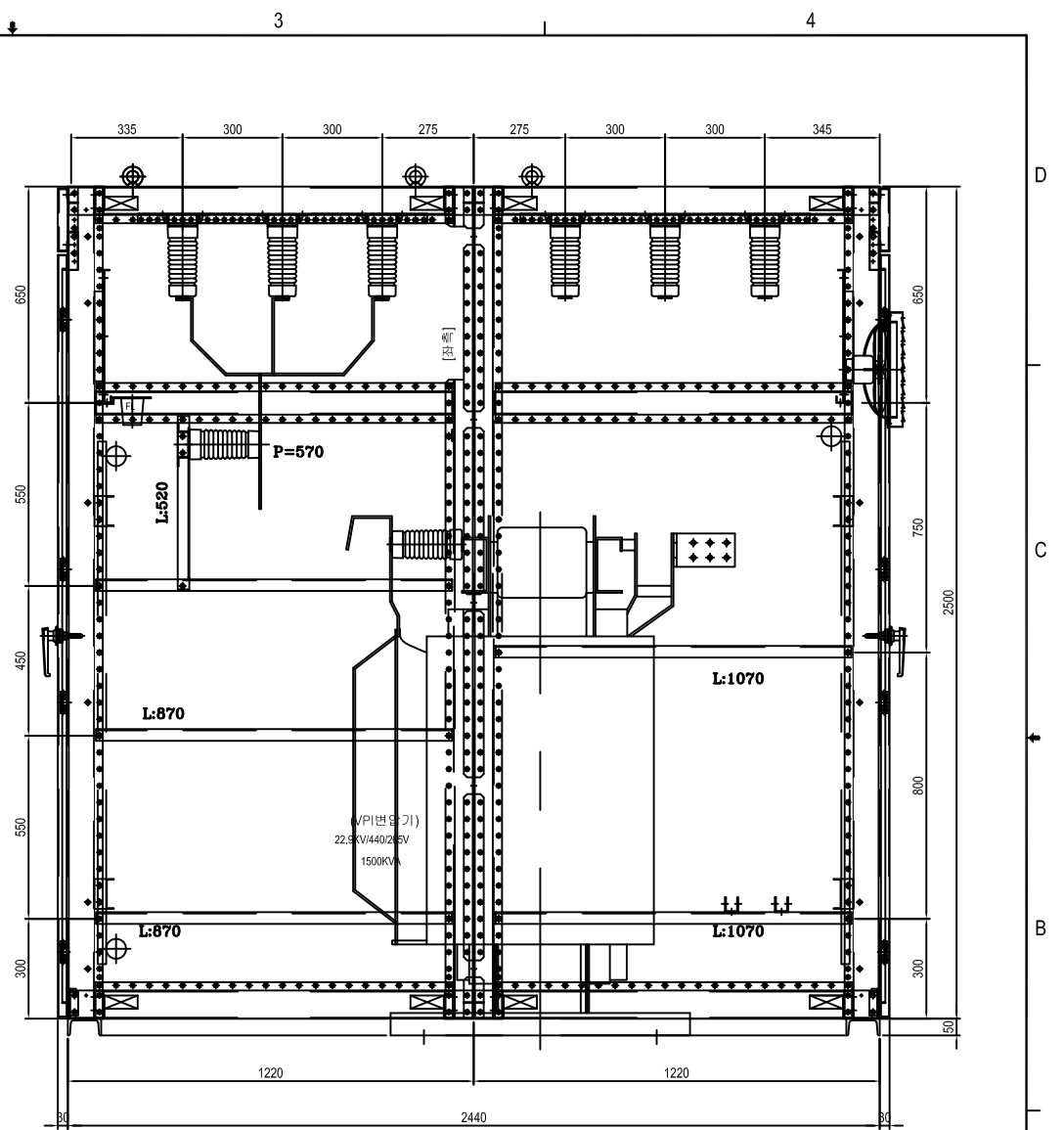

IN SIDE VIEW

REV.	DATE	BY	CHKD	APPD	DESCRIPTION
CLIENT					
CONTRACTOR					
PROJECT					
TITLE					SCALE
DRAWN					DATE DRAWN
CHECKED					DATE CHECKED
APPROVED					DATE APPROVED
NO.					NO.
PROJECT CLASSIFICATION					CLEARING NO.

(주)호원아이엔씨
HOWON Instrument & control Co., Ltd.

HV/LV PANEL
TR-2 PANEL LAYOUT

A3 (420 x 297 m/m)

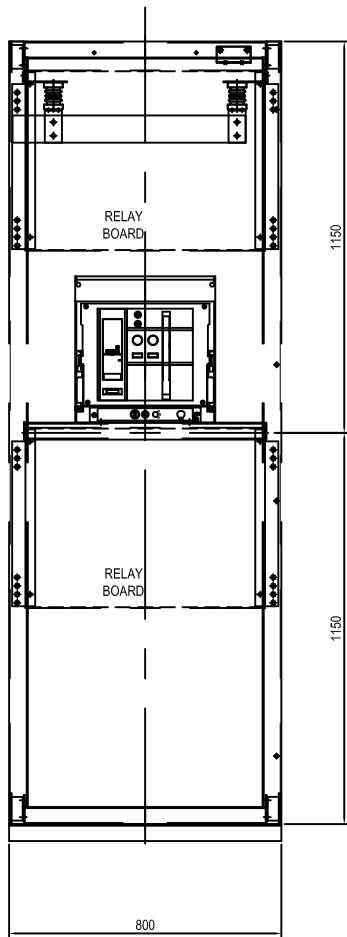

IN FRONT VIEW

ACB 3P
2500A
AN-25D3-25J

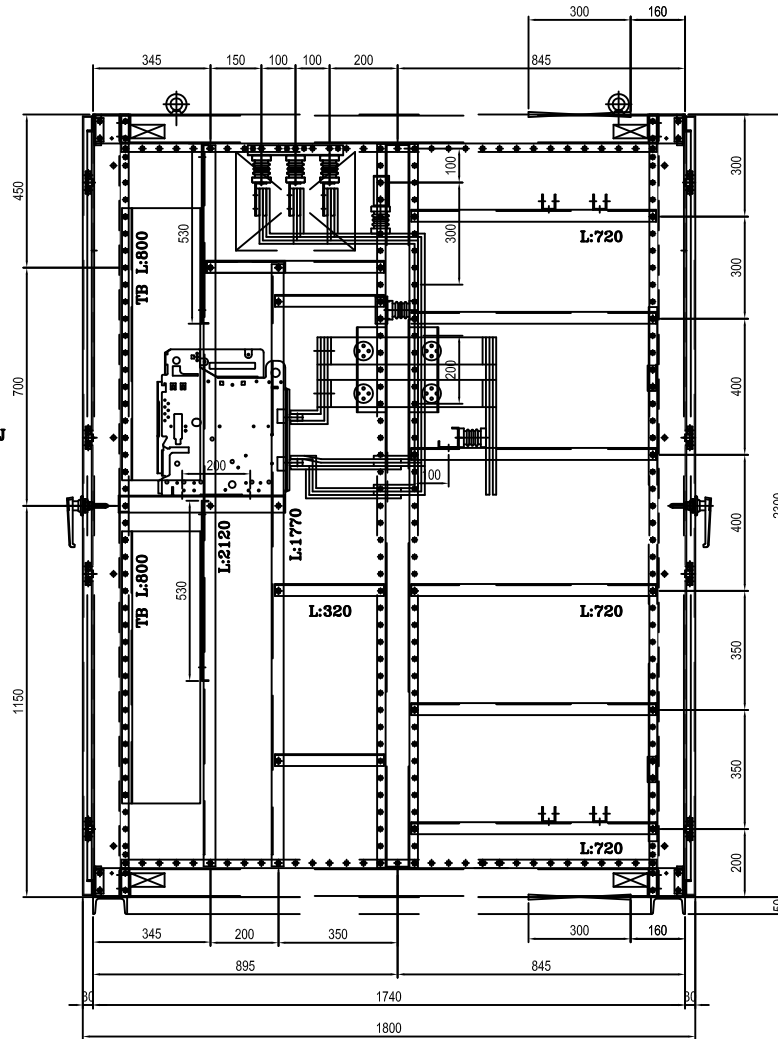

IN SIDE VIEW

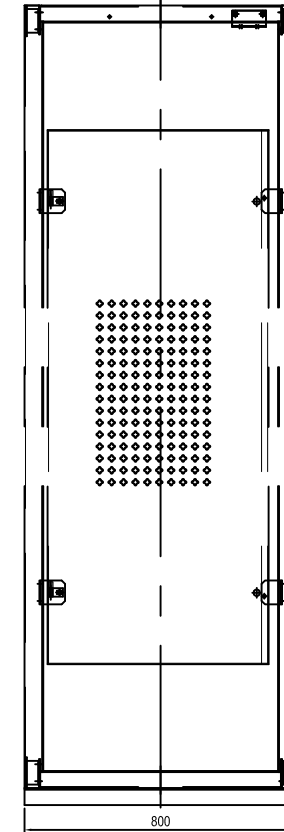

IN REAR VIEW

REV.	DATE	DRN	CHKD	APPD	DESCRIPTION
DRAWN					
CHECKED					
APPROVED					
SCALE	DATE DRAWN	DATE NO.			
NO.					

PROJECT: (주)호원아이앤씨
HWIN Instrument & control Co., Ltd.

TITLE: HV/LV PANEL
LV-1 PANEL LAYOUT

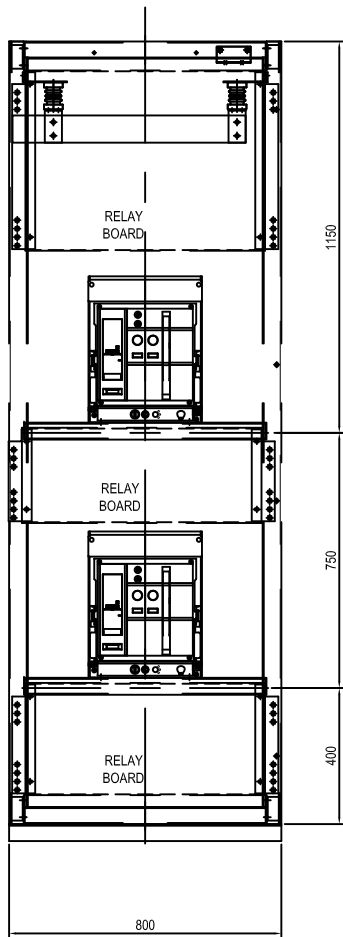

IN FRONT VIEW

ACB 3P
1250A/1000A
AN-12D3

ACB 3P
1250A/800A
AN-12D3

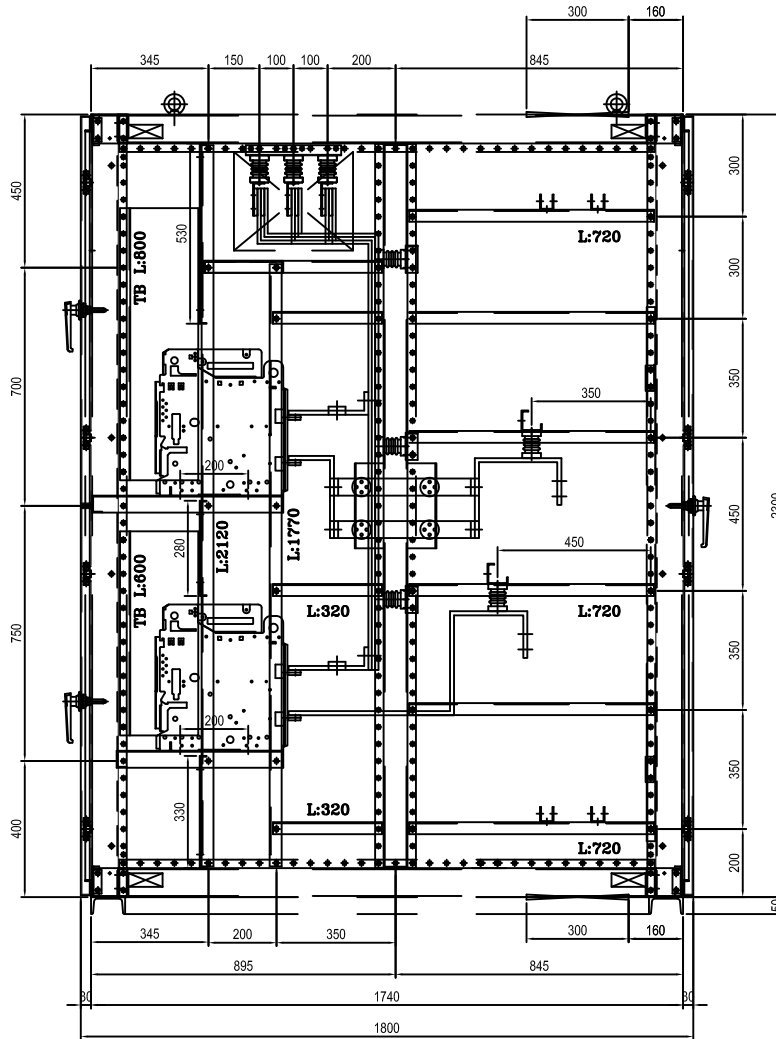

IN SIDE VIEW

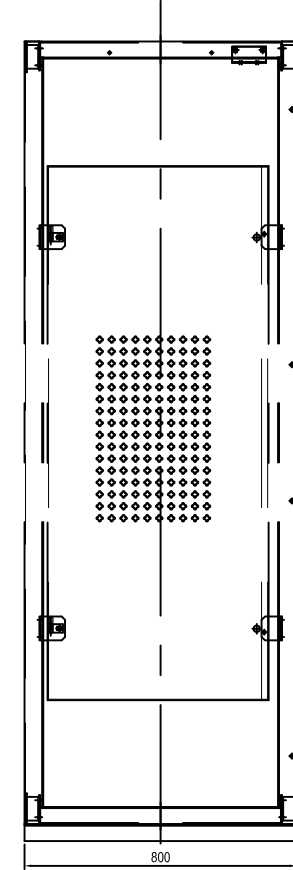

IN REAR VIEW

REV.	DATE	DRN	CHKD	APPD	DESCRIPTION
CLIENT					
CONTRACTOR					
 (주)호원아이앤씨 HWIN Instrument & Control Co., Ltd.					
PROJECT					
DRAWN					TITLE
CHECKED					HV/LV PANEL
APPROVED					LV-2 PANEL LAYOUT
SCALE	DATE DRAWN	DATE NO.			
NO.					
DESIGN CLASSIFICATION					

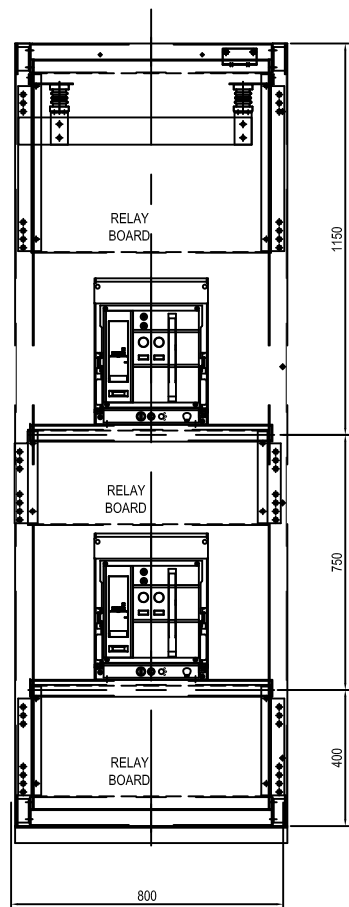

IN FRONT VIEW

ACB 3P
1250A/1000A
AN-12D3

ACB 3P
1250A/800A
AN-12D3

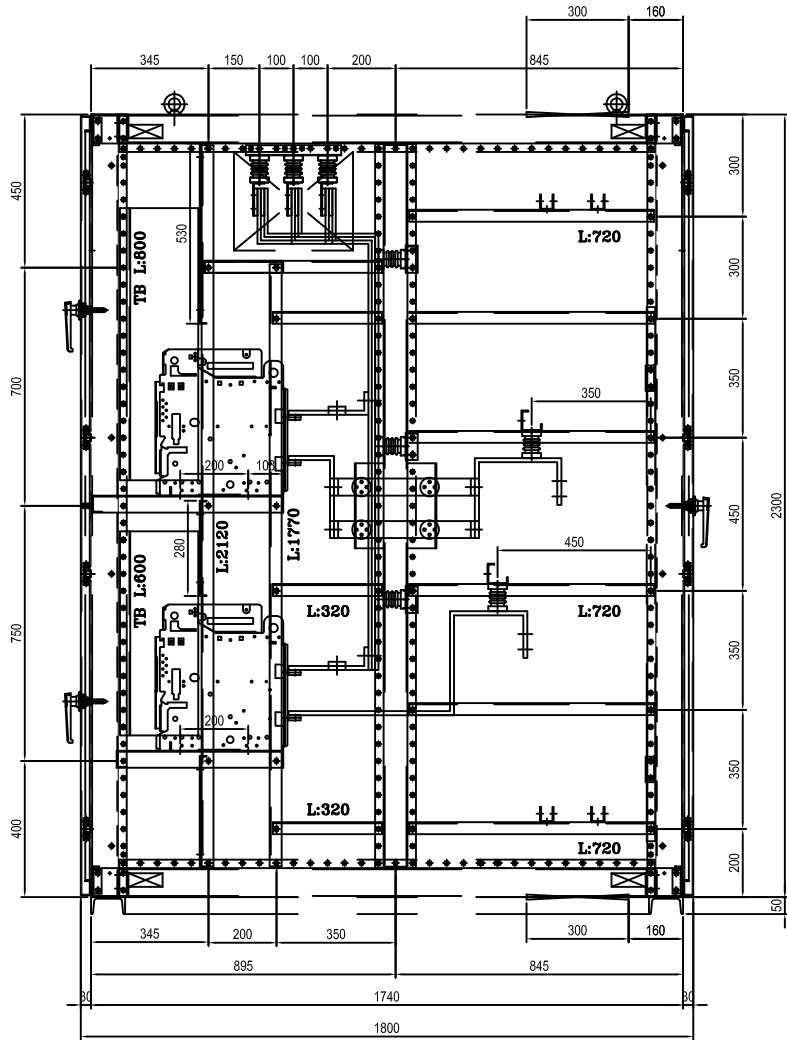

IN SIDE VIEW

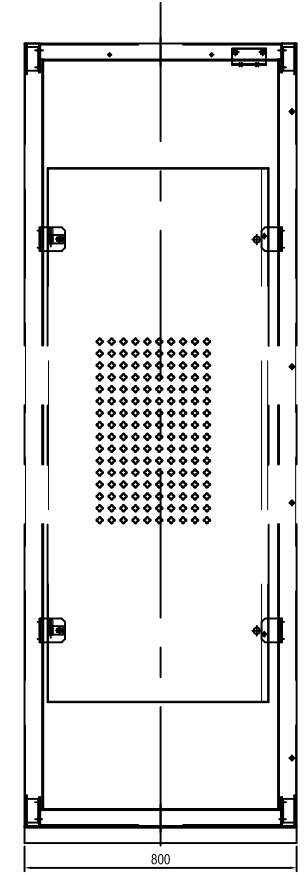

IN REAR VIEW

REV.	DATE	DRN	CHG	APPD	DESCRIPTION
CLIENT					
CONTRACTOR					
 (주)호원아이앤씨 HWIN Instrument & Control Co., Ltd.					
PROJECT					
DESIGNED BY	TITLE				
DRAWN	HV/LV PANEL				
CHECKED	LV-3 PANEL LAYOUT				
APPROVED					
SCALE	DATE DRAWN	DATE NO.			
NO.					
DESIGN-CHECKER/NO.	CLIENT-DWG. NO.				

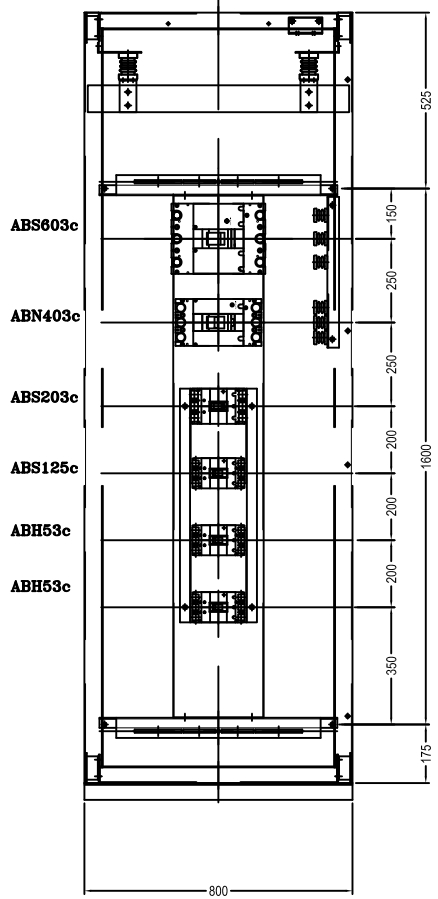

IN FRONT VIEW

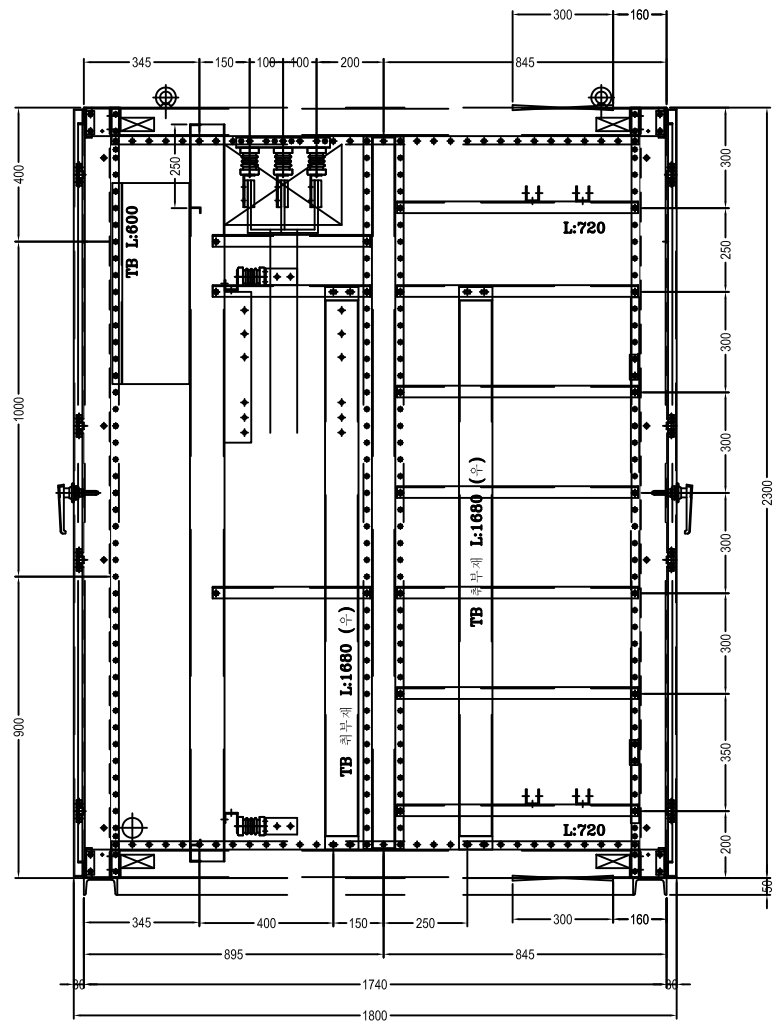

IN SIDE VIEW

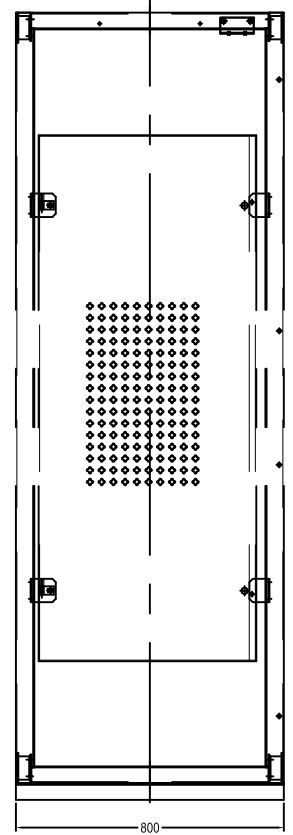

IN REAR VIEW

REV.	DATE	BY	CHKD	APPD	DESCRIPTION
DRAWN					
CHECKED					
APPROVED					
SCALE	DATE DRAWN	DATE NO.			
PROJECT					
CONTRACTOR					
 (주)호원아이앤씨 HWM Instrument & Control Co., Ltd.					
PROJECT					
DESIGN NO.	300040	TITLE	HV/LV PANEL		
DRAWN	S.Y.SUN	LV-4 PANEL LAYOUT			
CHECKED	SUNHLEE				
APPROVED	Y.B.YOO				
SCALE	DATE DRAWN	DATE NO.			
PROJECT					
CONTRACTOR					

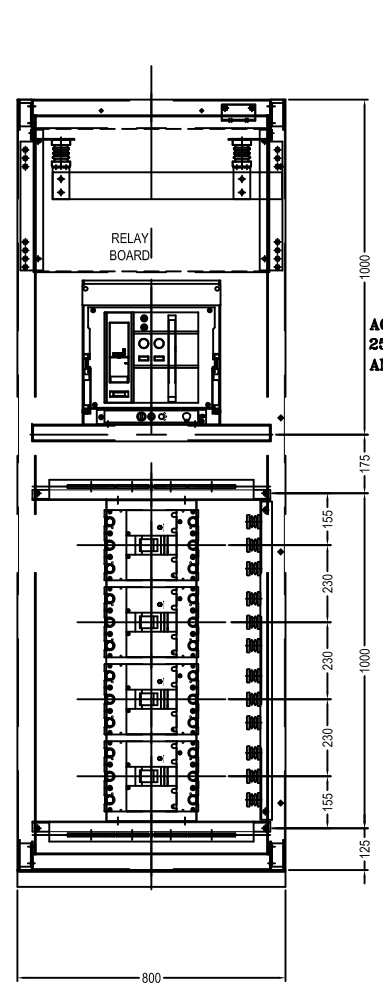

IN FRONT VIEW

ACB 3P
2500A
AN-25D3-25J

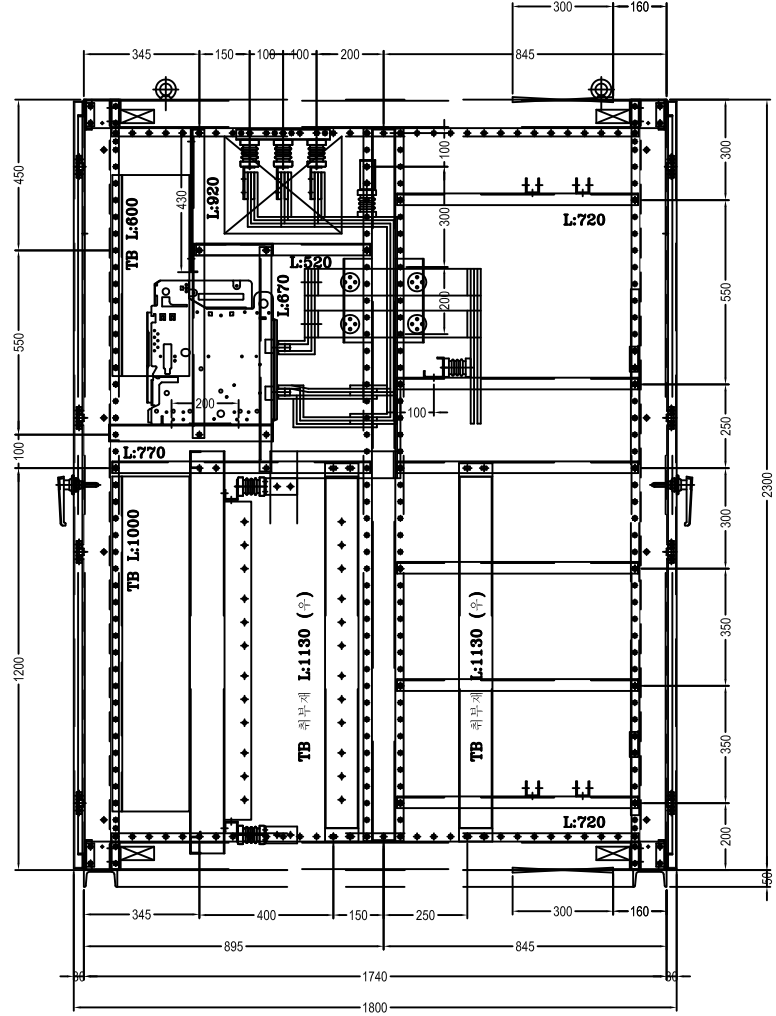

IN SIDE VIEW

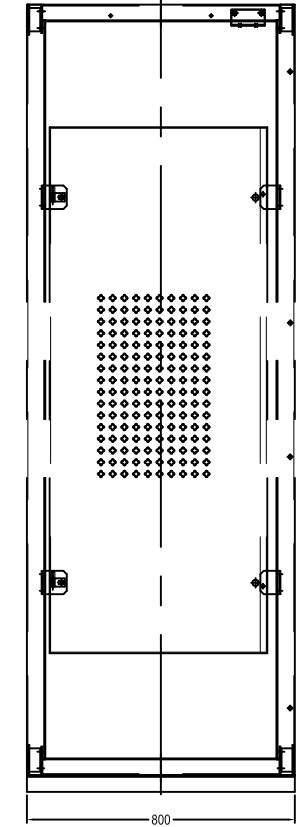

IN REAR VIEW

REV.	DATE	DRN	CHG	APPD	DESCRIPTION
CLIENT					
CONTRACTOR					
PROJECT					
(주)호원아이엔씨 Hwonn Instrument & Control Co., Ltd.					
PROJECT					
DESIGN DATE	2008.04	TITLE	HV/LV PANEL		
DRAWN	S.Y.SUN	LV-5 PANEL LAYOUT			
CHECKED	SUNHLEE				
APPROVED	Y.S.YOO				
SCALE	DATE DRAWN	DATE NO.			
DESIGN CONSULTANT: _____ CLIENT DRAWING NO.: _____					

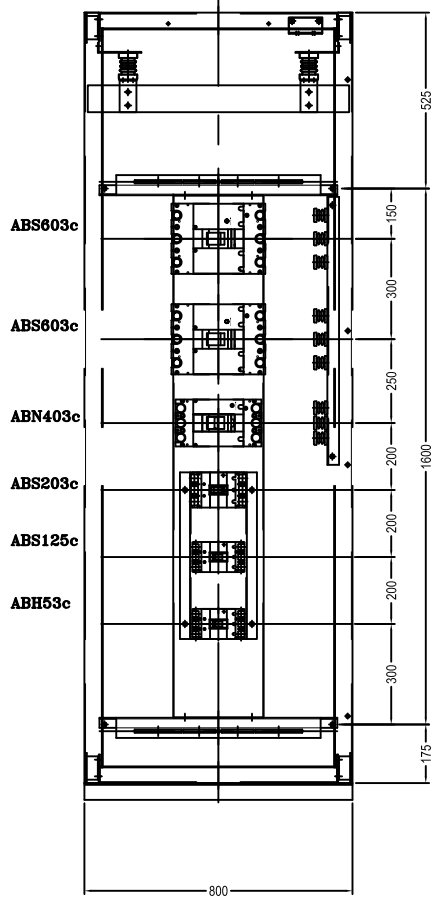

IN FRONT VIEW

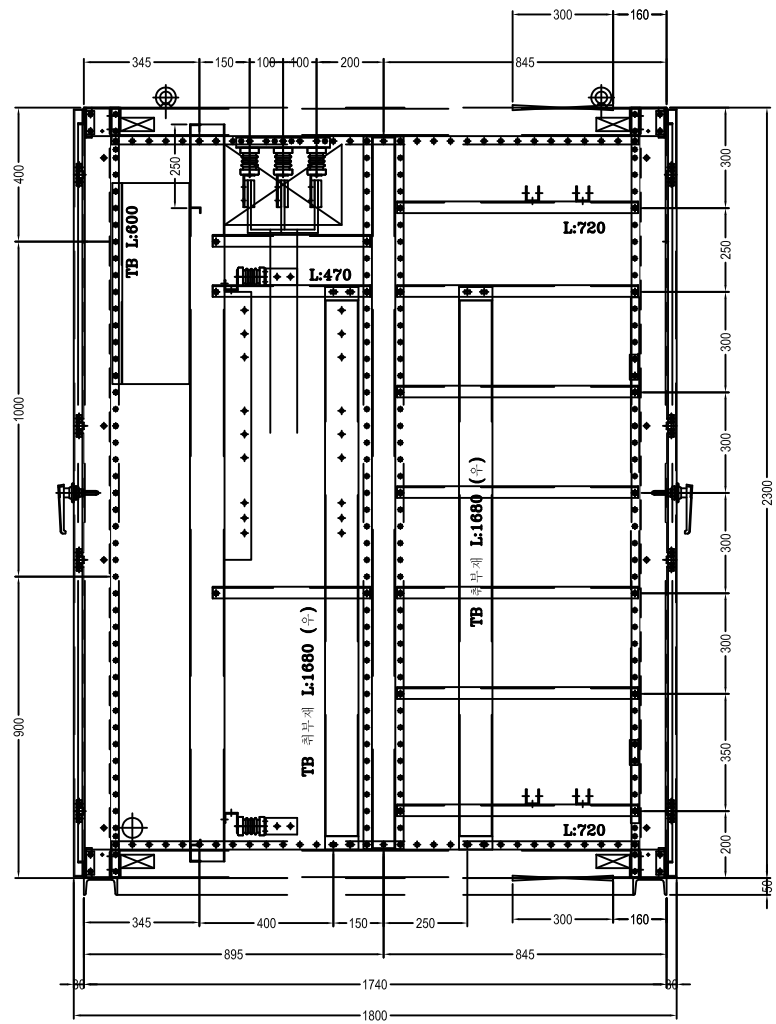

IN SIDE VIEW

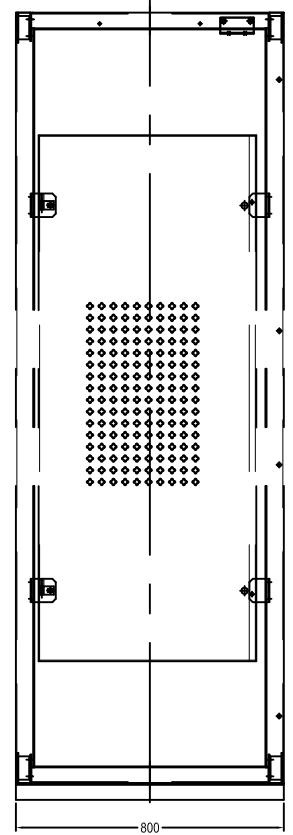

IN REAR VIEW

REV.	DATE	BY	CHKD	APPD	DESCRIPTION
DRAWN					
CONTRACTOR					
 (주)호원아이앤씨 HWIN Instrument & Control Co., Ltd.					
PROJECT					
DESIGN DATE	2009.04	TITLE	HV/LV PANEL		
DRAWN	S.Y.SUN	LV-6 PANEL LAYOUT			
CHECKED	SUNHLEE				
APPROVED	Y.B.YOO				
SCALE	DATE DRAWN	DATE NO.			
DESIGN CONSULTANT		CLIENT			

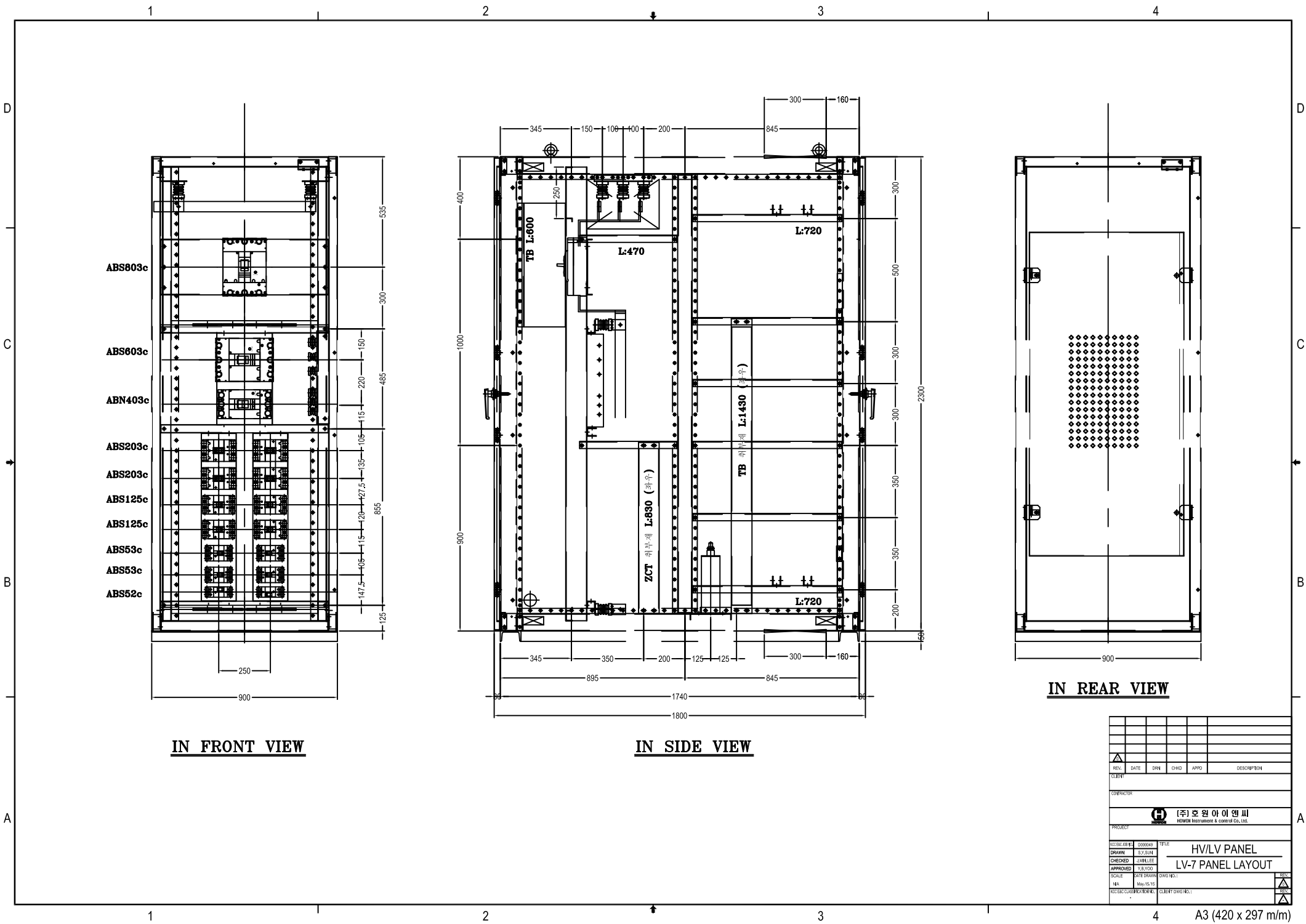

ABS803c

ABS603c

ABN403c

ABS203c

ABS203c

ABS125c

ABS125c

ABS53c

ABS53c

ABS52c

IN FRONT VIEW

IN SIDE VIEW

IN REAR VIEW

REV.	DATE	DRN	CHKD	APPD	DESCRIPTION

CLIENT: _____

CONTRACTOR: _____

PROJECT: _____

(주)호원아이앤씨
 HWM Instrument & Control Co., Ltd.

TITLE: **HV/LV PANEL**
LV-7 PANEL LAYOUT

DRAWN: S.Y.SUN
 CHECKED: JUNGHEE
 APPROVED: Y.S.YOO

SCALE: _____ DATE DRAWN: _____ DATE REV.: _____
 NO.: _____ REV. NO.: _____ CLIENT DRAWING NO.: _____

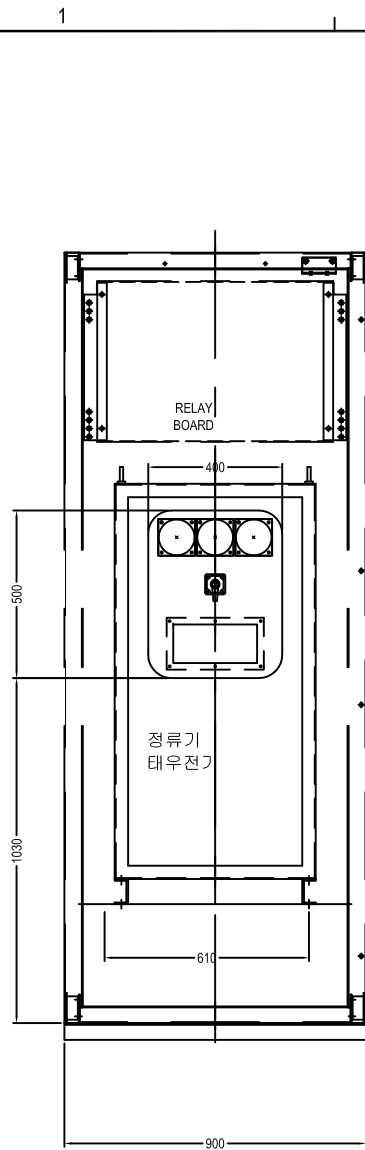

IN FRONT VIEW

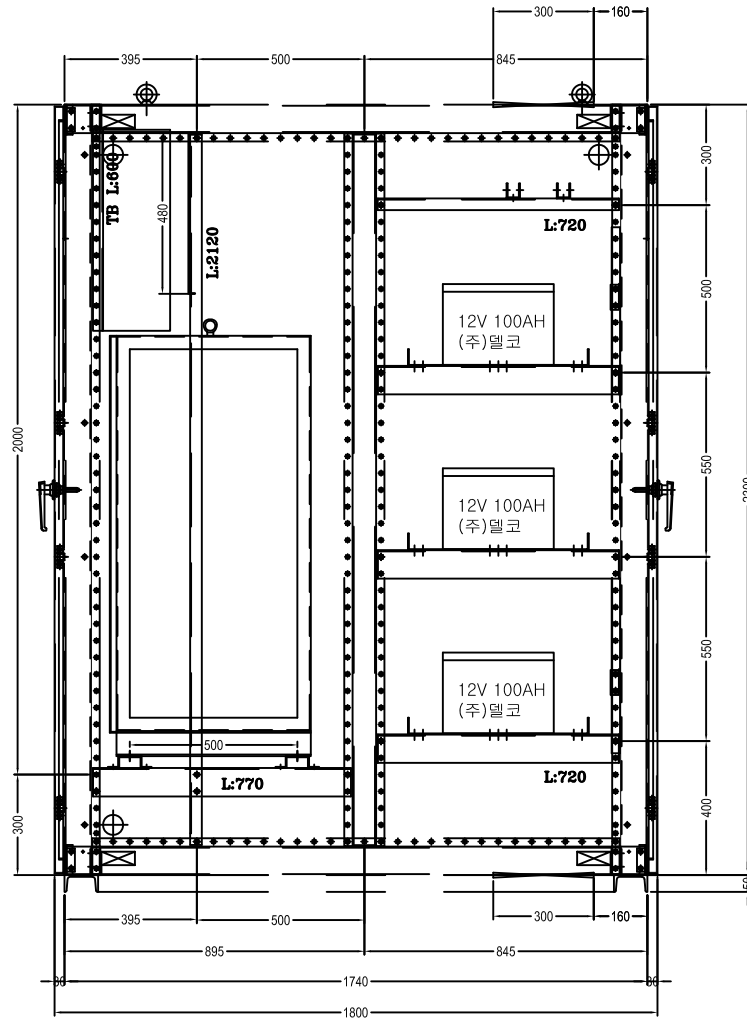

IN SIDE VIEW

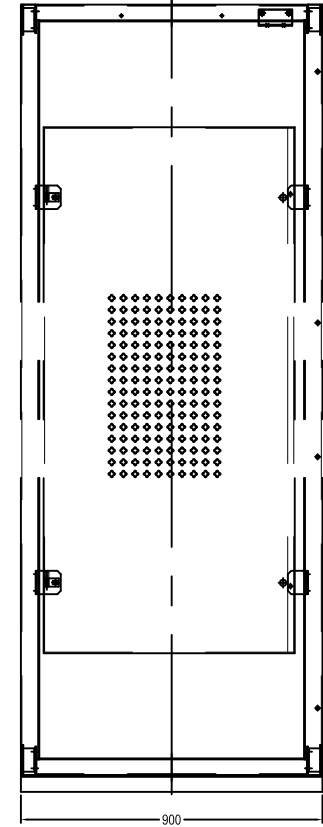

IN REAR VIEW

REV.	DATE	DRN	CHKD	APPD	DESCRIPTION
CLIENT					
CONTRACTOR					
 (주)호원아이앤씨 HWIN Instrument & Control Co., Ltd.					
PROJECT					
DESIGNER	300048	TITLE			
DRAWN	S.Y.SUN	HV/LV PANEL			
CHECKED	JUNHLEE	LV-R PANEL LAYOUT			
APPROVED	Y.B.YOO	SCALE	DATE DRAWN	DATE NO.	
DESIGN CONSULTANT					CLIENT DRAWING NO.

1 2 3 4

D
C
B
A

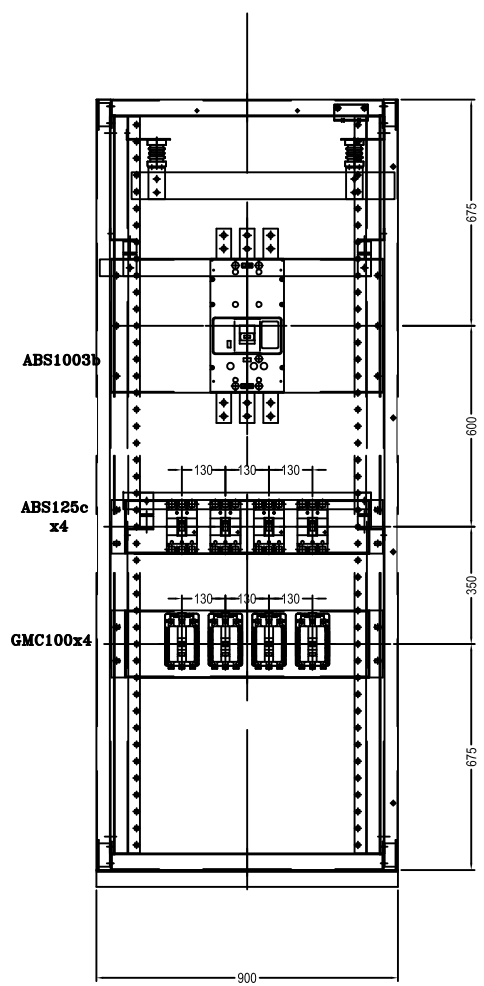

IN FRONT VIEW

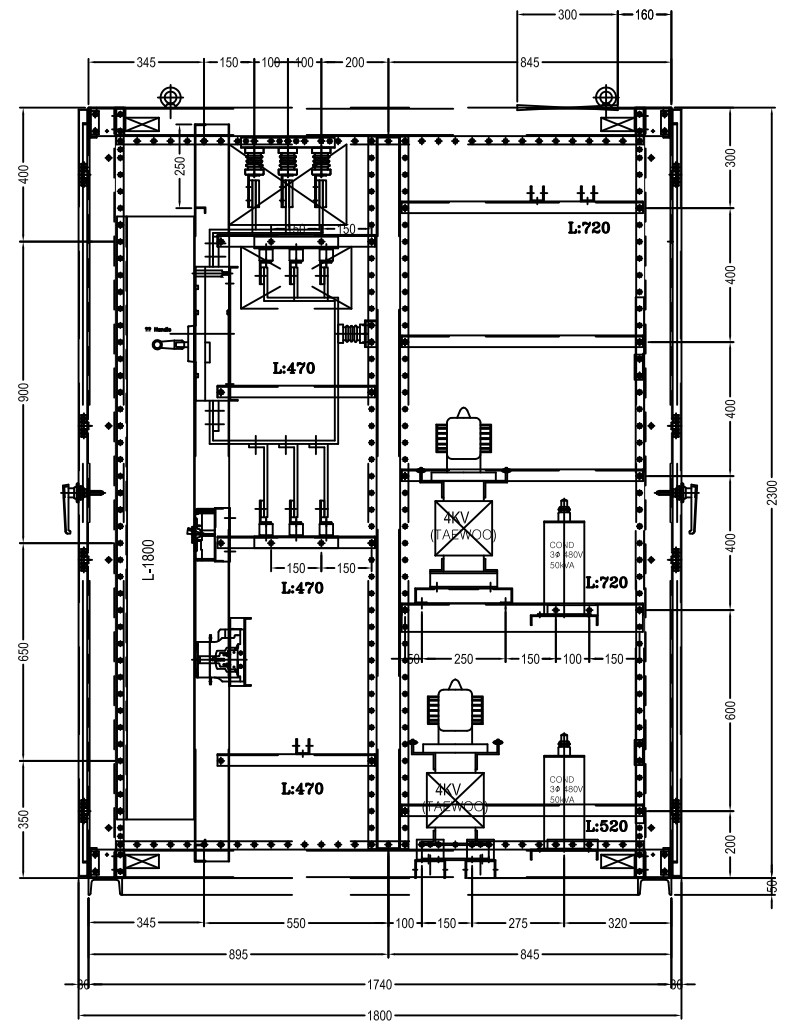

IN SIDE VIEW

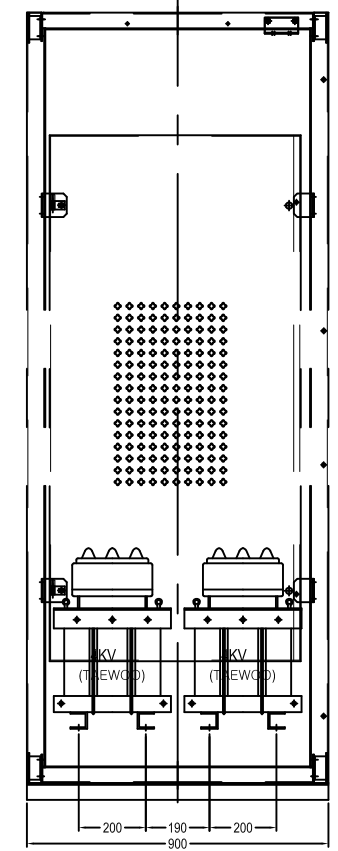

IN REAR VIEW

REV.	DATE	DRN	CHKD	APPR	DESCRIPTION
CLIENT					
CONTRACTOR					
(주)호원아이앤씨 HWIN Instrument & Control Co., Ltd.					
PROJECT					
DESIGN DATE	200804	TITLE	HV/LV PANEL		
DRAWN	S.Y.SUN	CHECKED	LV-C1 PANEL LAYOUT		
APPROVED	Y.B.YOO	SCALE	DATE DRAWN	DATE NO.	
DESIGN CONSULTANT					CLIENT DRAWING NO.

1 2 3 4

1 2 3 4

D
C
B
A

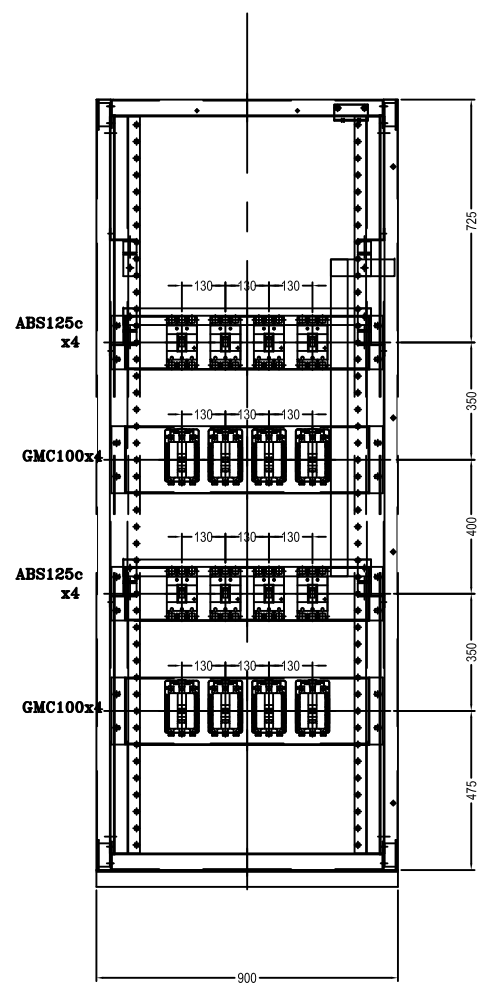

IN FRONT VIEW

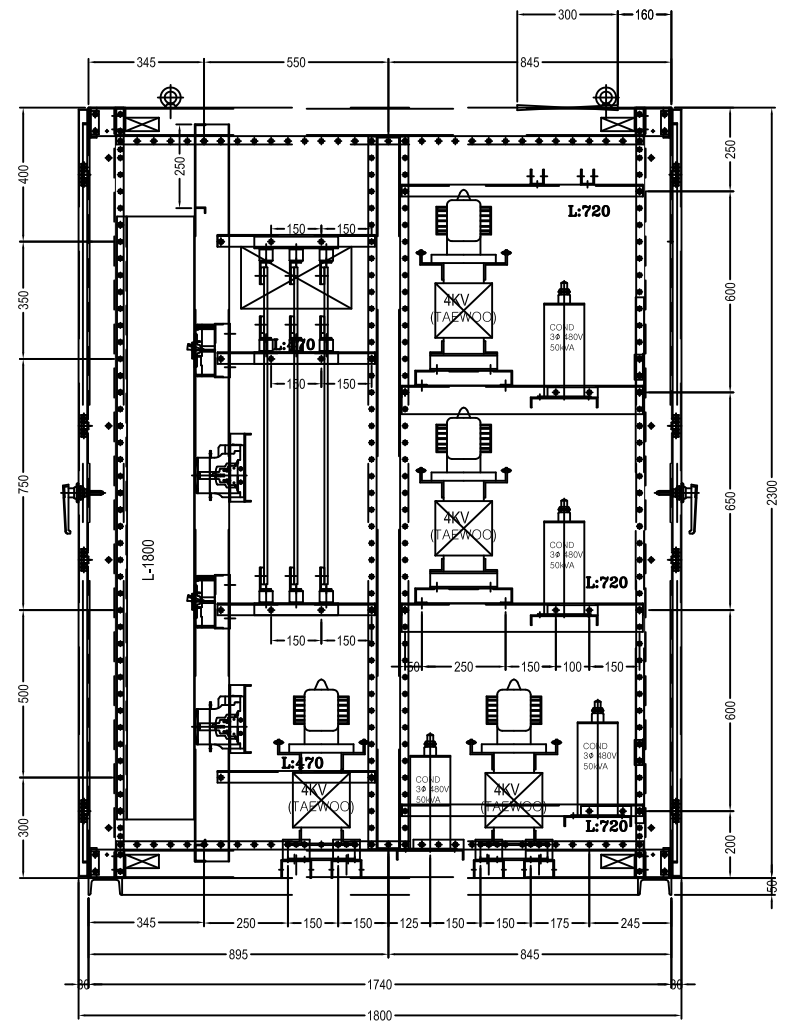

IN SIDE VIEW

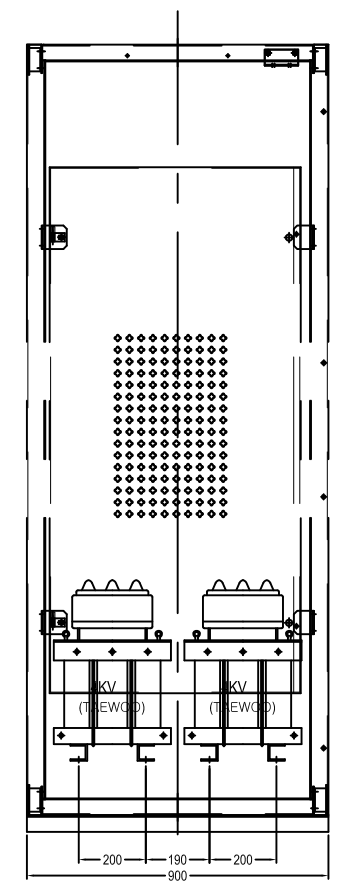

IN REAR VIEW

REV.	DATE	DRN	CHKD	APPD	DESCRIPTION
CLIENT					
CONTRACTOR					
 (주)호원아이앤씨 HWM Instrument & Control Co., Ltd.					
PROJECT					
DESIGNER	300040	TITLE	HV/LV PANEL		
DRAWN	S.Y.SUN	LV-C2 PANEL LAYOUT			
CHECKED	JUNHLEE				
APPROVED	Y.B.YOO				
SCALE	DATE DRAWN	DATE NO.			
N/A					
DESIGN-CHECKER/DATE		CLIENT-DWG. NO.			

1 2 3 4

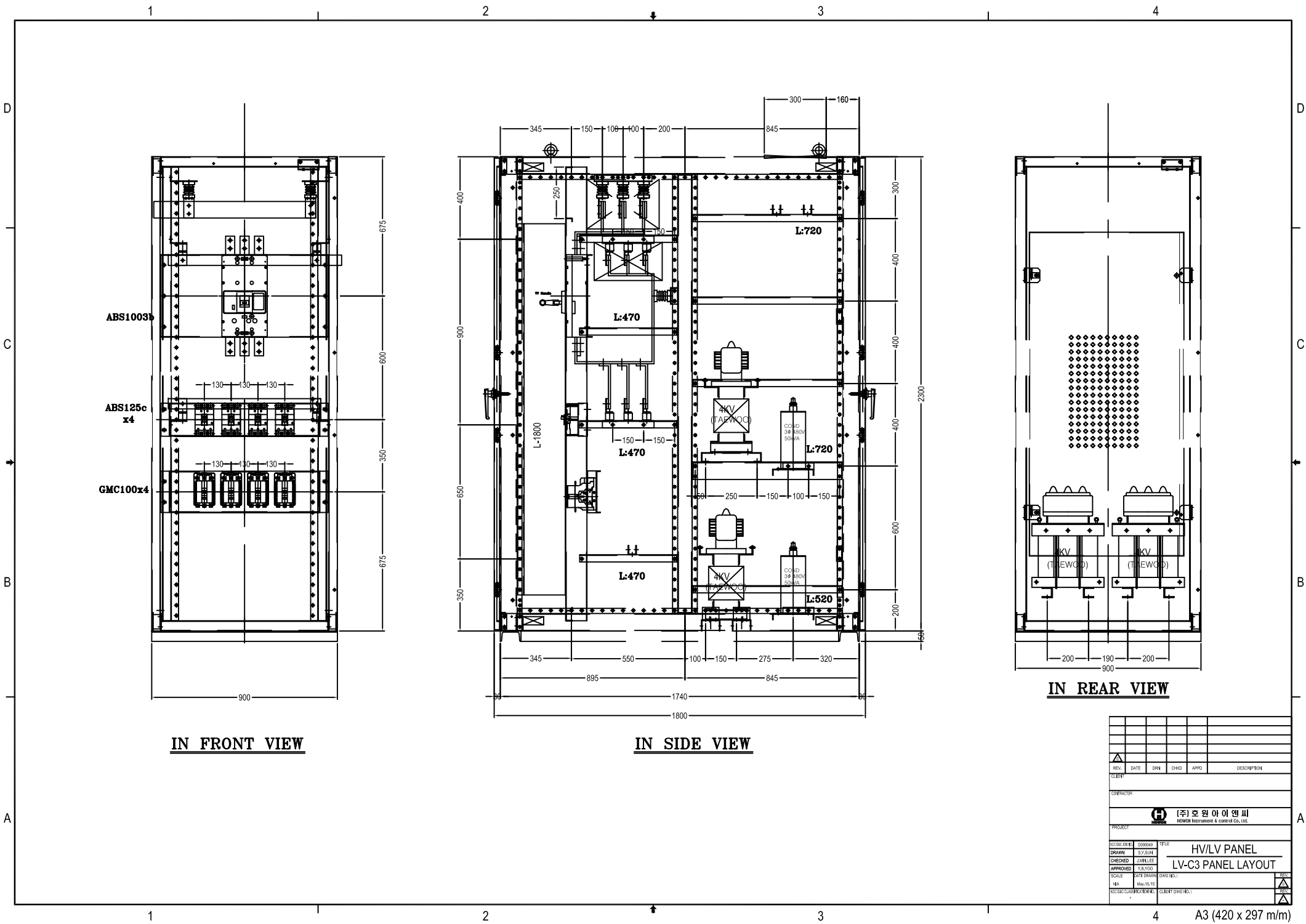

IN FRONT VIEW

IN SIDE VIEW

IN REAR VIEW

REV.	DATE	DRN	CHKD	APPD	DESCRIPTION
CLIENT					
CONTRACTOR					
 (주)호원아이앤씨 HWIN Instrument & Control Co., Ltd.					
PROJECT					
DESIGN DATE	200804	TITLE		HV/LV PANEL	
DRAWN	S.Y.SUN	CHECKED		JUNHLEE	
APPROVED	Y.S.YOO	CLIENT DRAWING NO.			
SCALE	DATE DRAWN	DATE NO.			

1 2 3 4

D
C
B
A

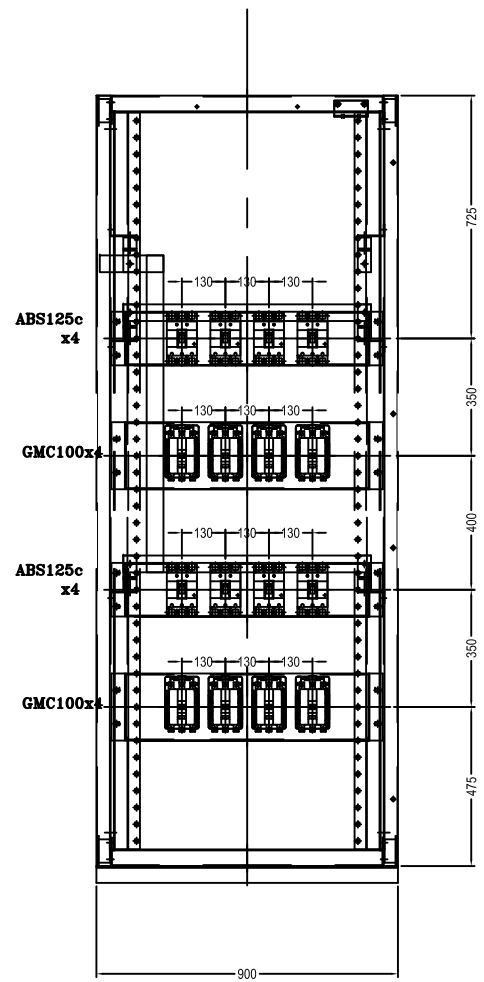

IN FRONT VIEW

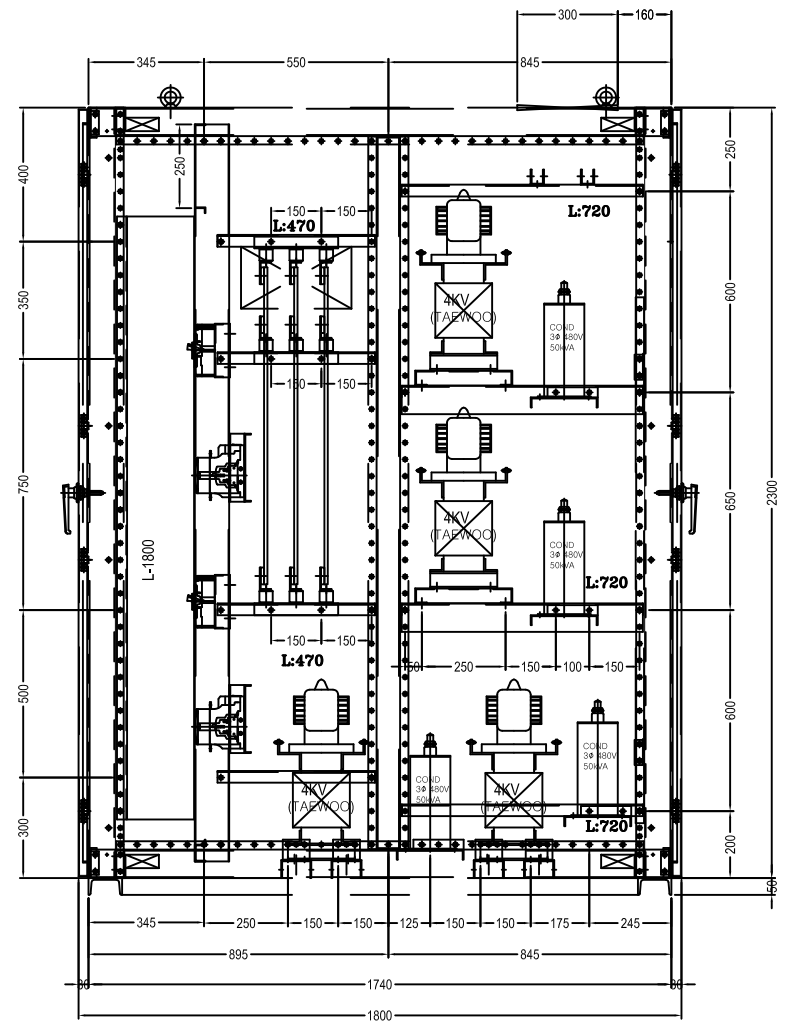

IN SIDE VIEW

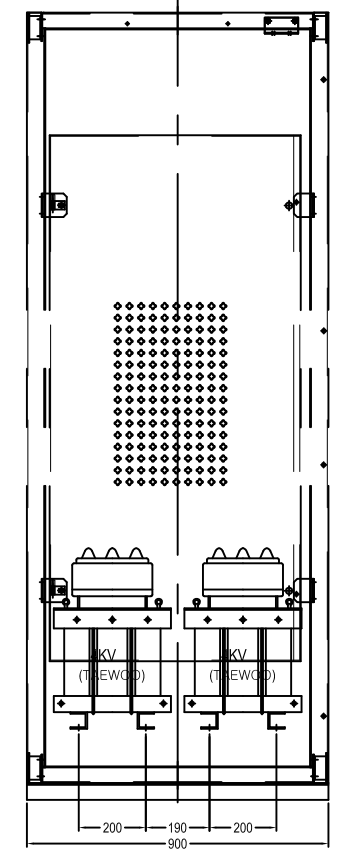

IN REAR VIEW

REV.	DATE	DRN	CHKD	APPD	DESCRIPTION
CLIENT					
CONTRACTOR					
 (주)호원아이앤씨 HWM Instrument & Control Co., Ltd.					
PROJECT					
DESIGNER	300040	TITLE	HV/LV PANEL		
DRAWN	3.3.2018	LV-C4 PANEL LAYOUT			
CHECKED	MINHLEE				
APPROVED	Y.B.YOO				
SCALE	DATE DRAWN	DATE NO.			
N/A	18/03/2018				
DESIGN CONSULTANT		CLIENT DRAWING NO.			

1 2 3 4

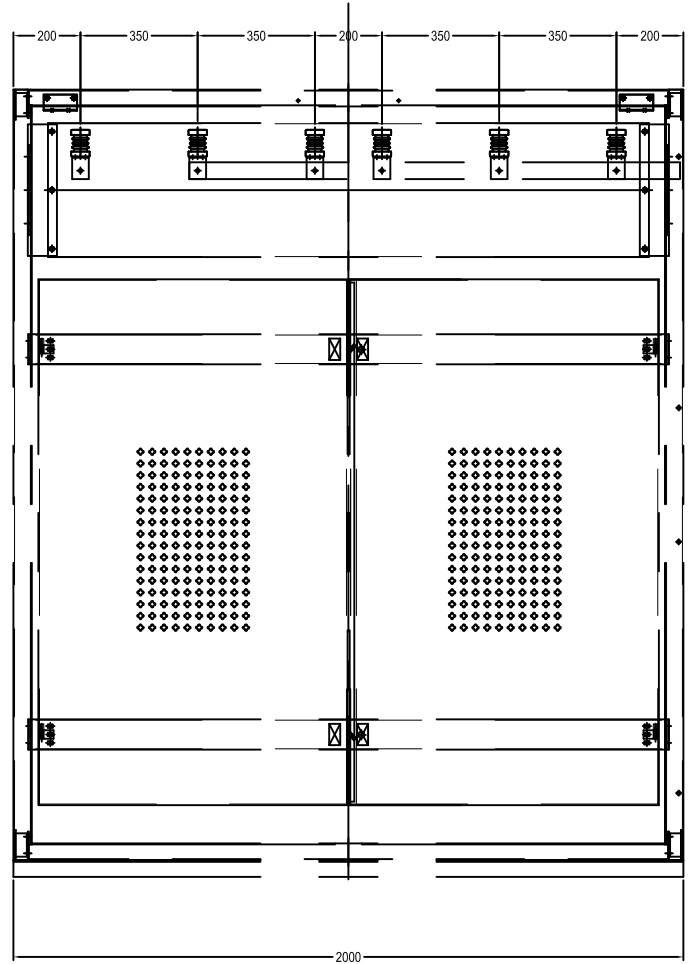

IN FRONT VIEW

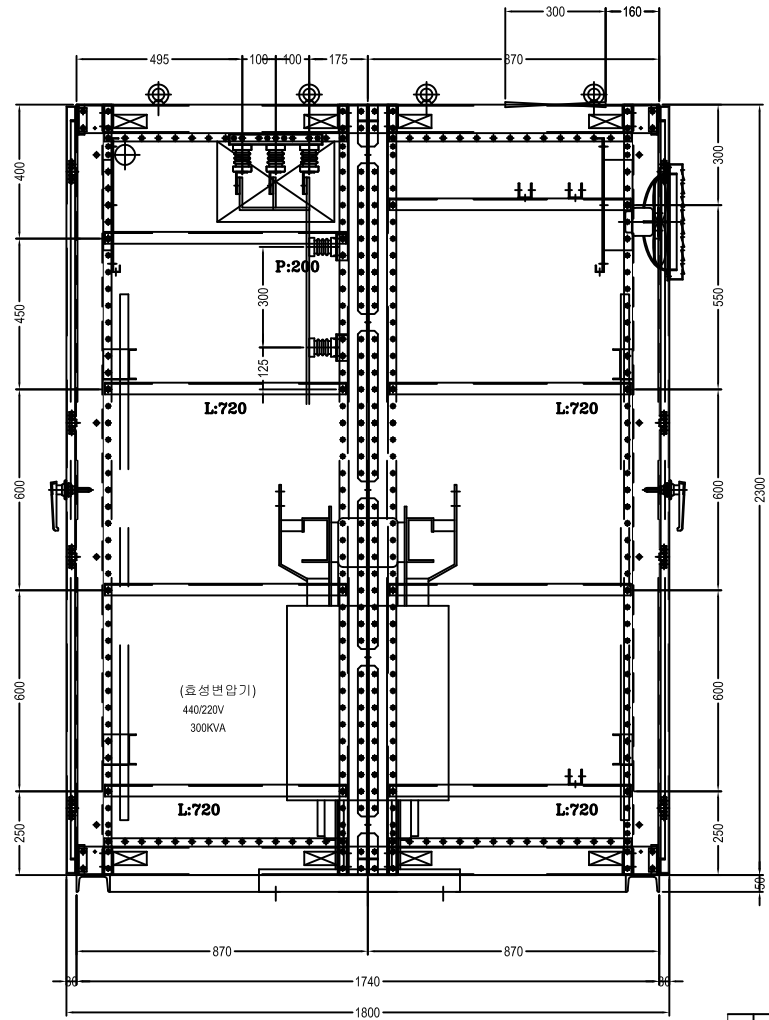

IN SIDE VIEW

REV.	DATE	DRN	CHKD	APPR	DESCRIPTION
CLIENT					
CONTRACTOR					
 (주)호원아이앤씨 HWIN Instrument & Control Co., Ltd.					
PROJECT					
DESIGNER	300040	TITLE			
DRAWN	S.Y.SUN	HV/LV PANEL			
CHECKED	SUNHLEE	TR-3 PANEL LAYOUT			
APPROVED	Y.B.YOO	SCALE	DATE DRAWN	DATE NO.	

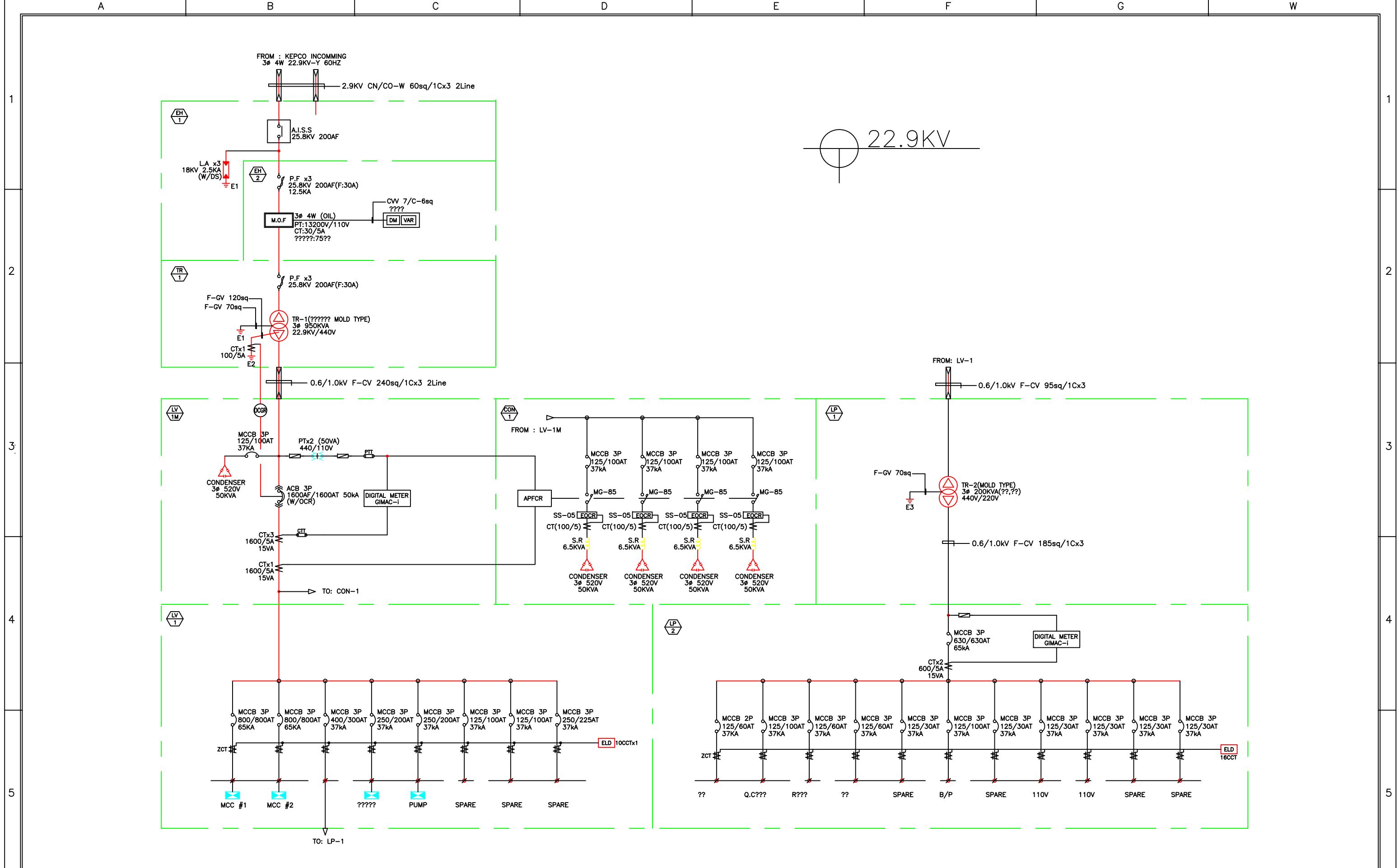

4					PROJECT	APPROVED BY	CHECKED BY	TITLE			
3						DESIGNED BY & DRAWN BY		SINGLE LINE DIAGRAM			
2						DATE	SCALE	UNIT	WORK NO.	DRAWING NO.	WHEET NO.
1											
REV.	DATA	CONTENTS	REV'D BY	CHK'D BY	APP'D BY						
A	B	C	D	E	F	G	W				

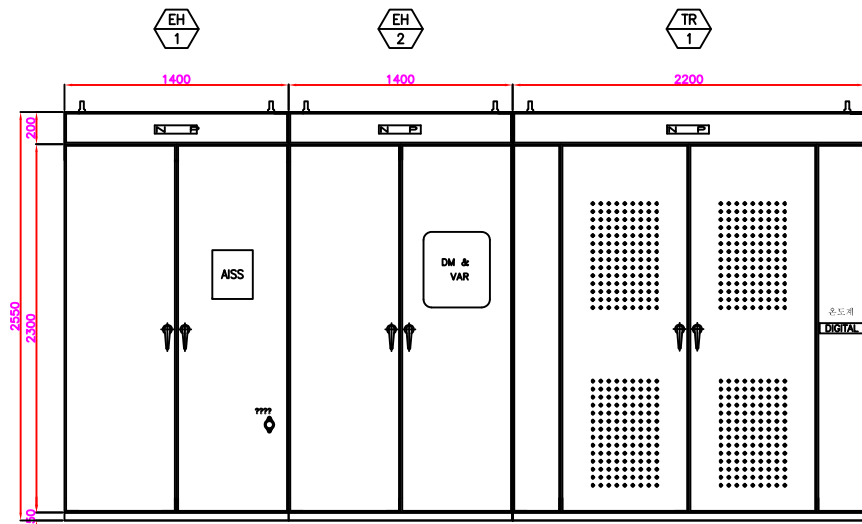

 (주) 호원아이엔씨
 HOWON Instrument & control Co., Ltd.

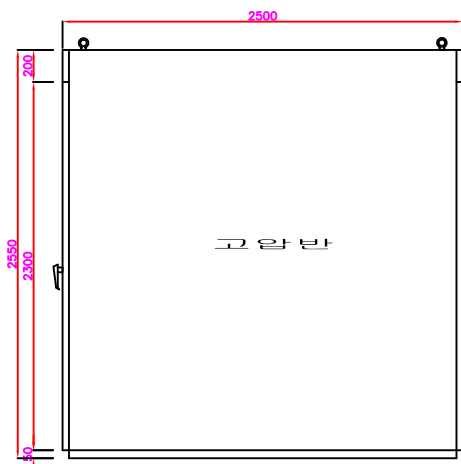

고압반 FRONT VIEW

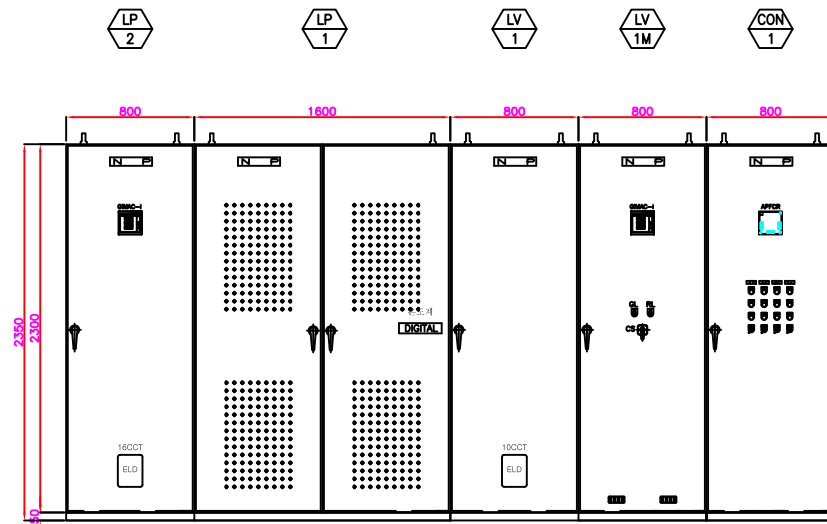

고압반 SIDE VIEW



저압반 FRONT VIEW

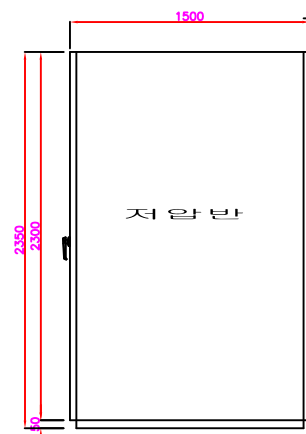

저압반 SIDE VIEW

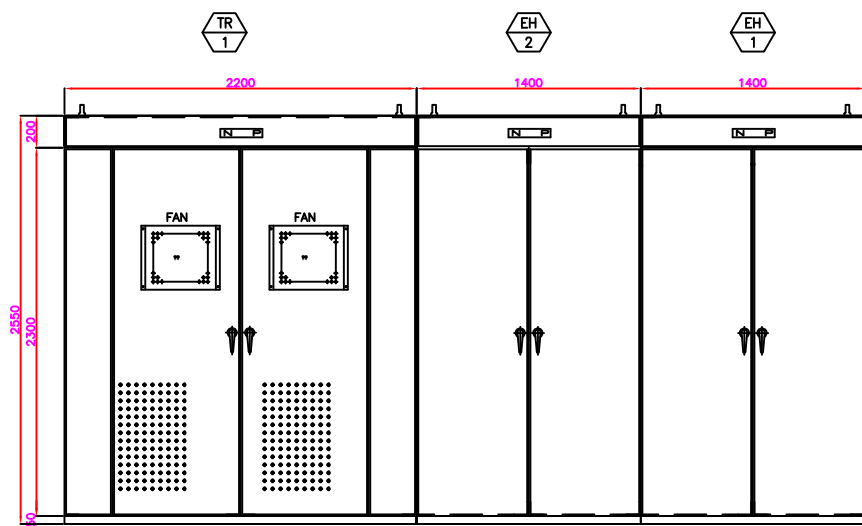

고압반 REAR VIEW

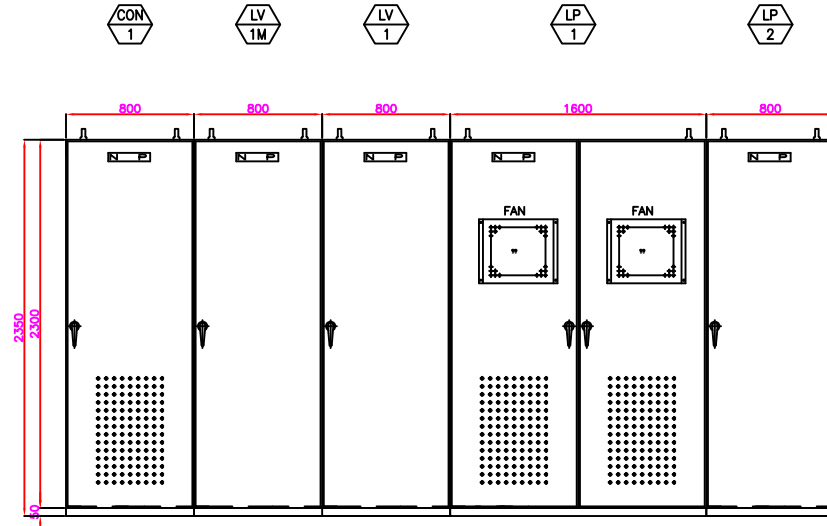

저압반 REAR VIEW

NOTE

1. ????? FAN? ????? ?? ????? ON/OFF? ??? ??, ?? ?? ????? ????? ???? ?? ??.
2. CUBICLE ??? "?" CHANNEL? CUBICLE?? ??? ???.
3. CUBICLE : ?????
?? : 3.2 t STEEL PLATE
?? : 2.3 t STEEL PLATE
4. CUBICLE ??? "?" CHANNEL? ??? 100x100x50x5t ?.
5. ??? STEEL PLATE 5t??

4					
3					
2					
1					
REV.	DATA	CONTENTS	REV'D BY	CHK'D BY	APP'D BY

PROJECT



(주) 호원아이엔씨
HOWON Instrument & control Co., Ltd.

APPROVED BY

CHECKED BY

TITLE

DESIGNED BY & DRAWN BY

22.9KV PANEL LAYOUT

DATE

SCALE

UNIT

WORK NO.

DRAWING NO.

WHEET NO.

FROM: KEPCO PAD SWITCH 지중인입선로(L=2138m)
 CABLE: 22.9KV CNC0-W 3-1C/200mmSQ(FEP 150mmDIA)

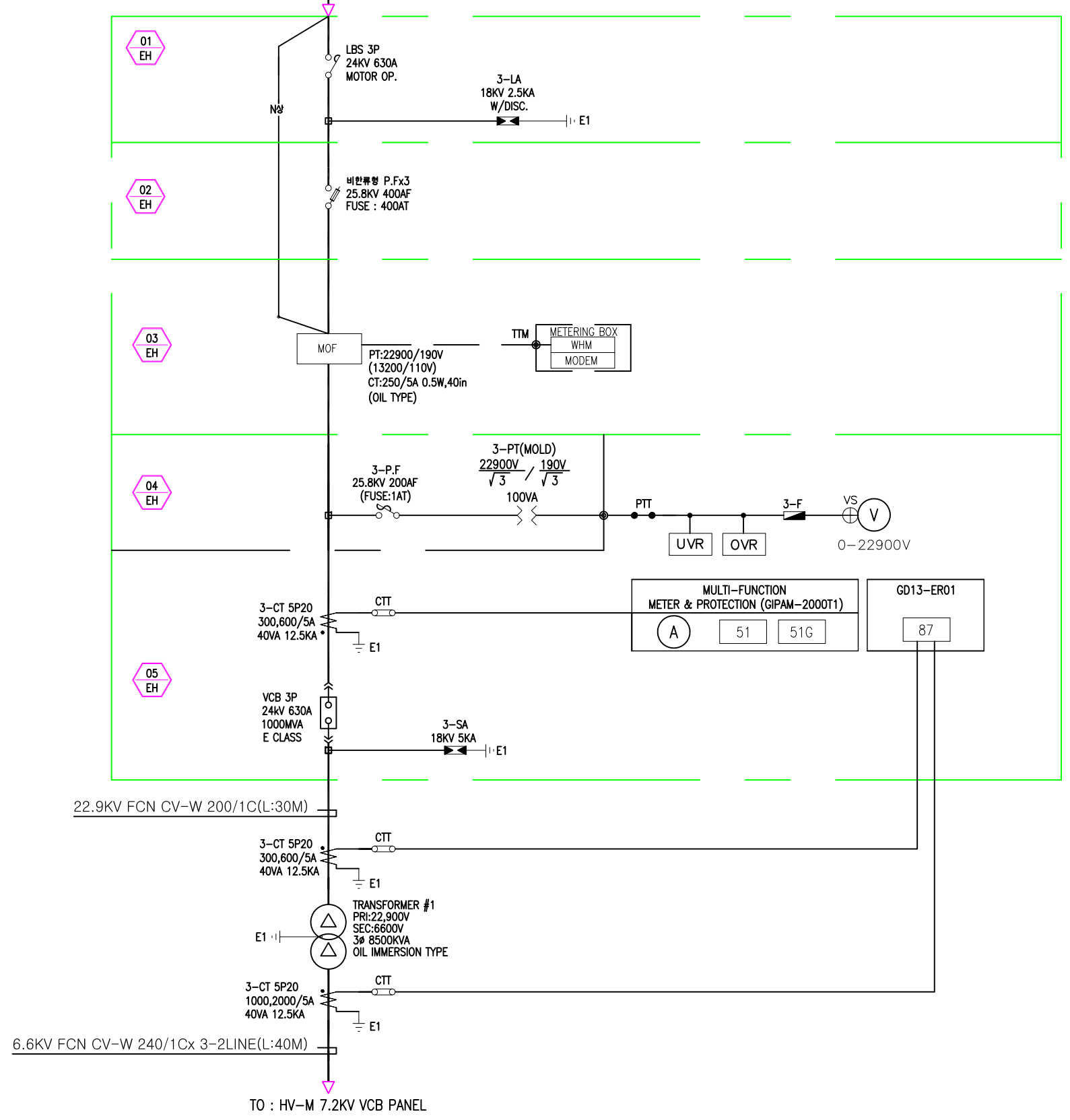

							CUSTOMER			TITLE	SINGLE LINE DIAGRAM		SCALE	NONE
							PROJECT			DWG No.			DATE	
													CONT.No.	
NO.	DATE	REVISIONS	PREPARER	CHECKER	REVIEWER	APPROVER	 (주) 호원아이엔씨 HOWON Instrument & control Co., Ltd.							
1														

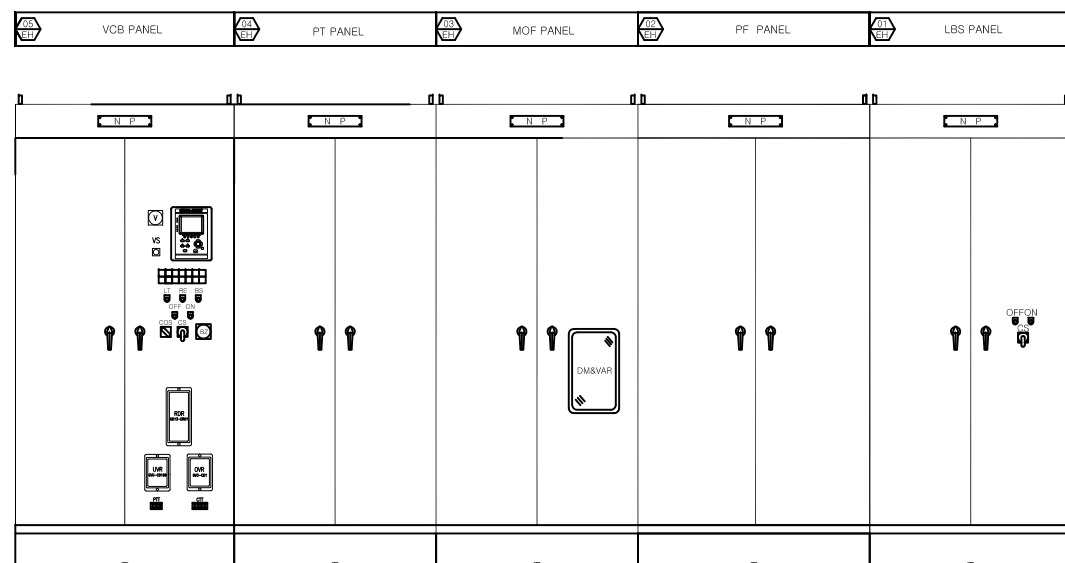

FRONT VIEW

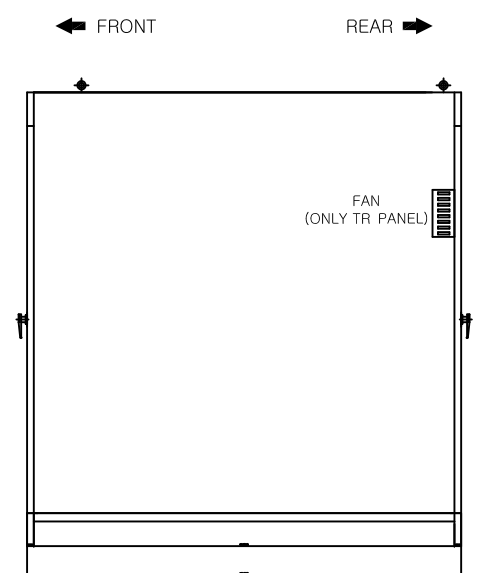

SIDE VIEW

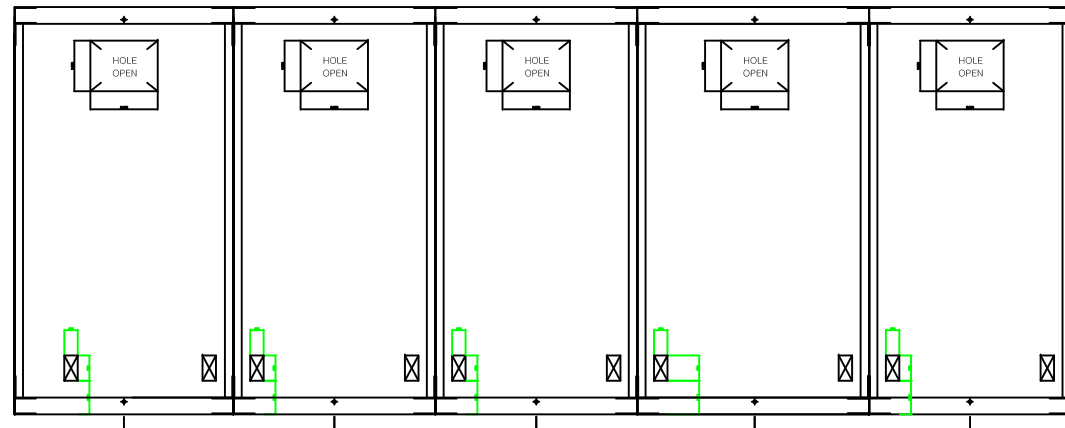

BASE VIEW

NOTE :

No.	ITEM	DESCRIPTION	REMARK
1	MATERIAL	SS41	
2	THICKNESS	2.3T	
3	COLOR	MUNSEL No.5Y7/1	

△	NO.	DATE	REVISIONS	PREPARER	CHECKER	REVIEWER	APPROVER	CUSTOMER	TITLE	SCALE	NONE	
								PROJECT		DWG No.	DATE	
										SHEET No.	CONT.No.	

특고압 수배전반 LAYOUT



(주) 호원아이엔씨
HOWON Instrument & control Co., Ltd.

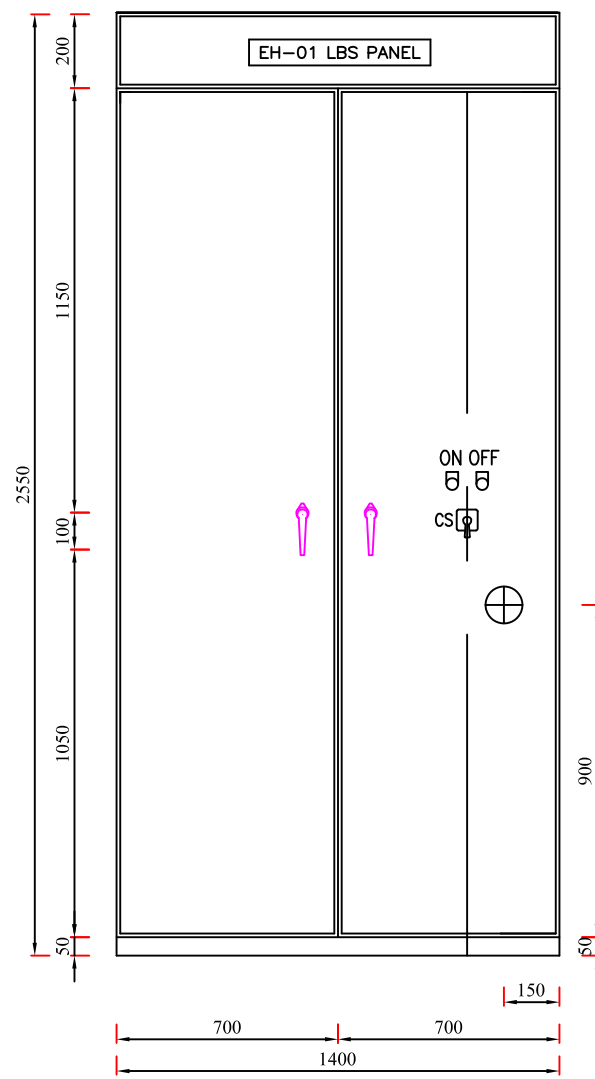

FRONT VIEW

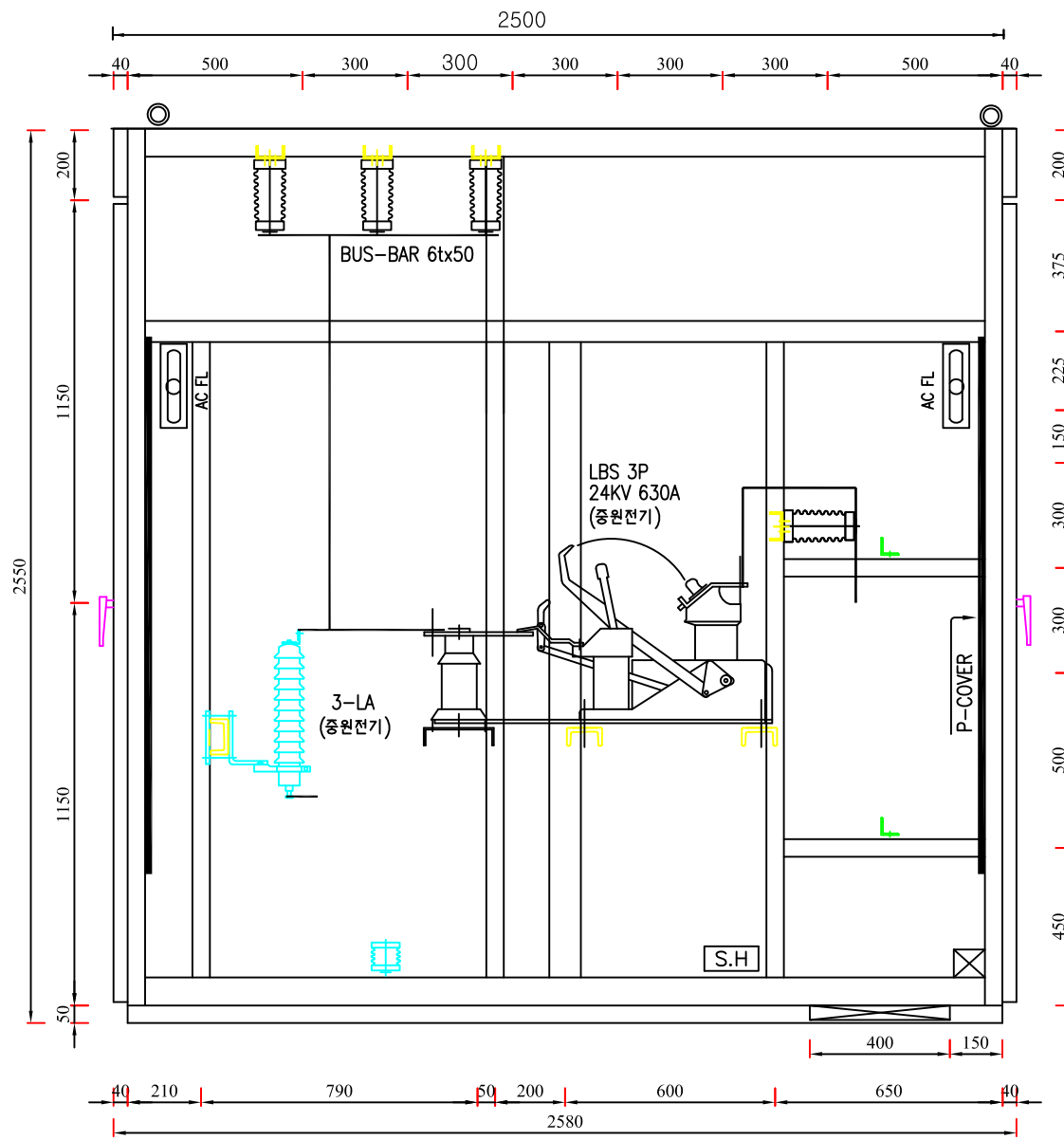

INNER SIDE VIEW

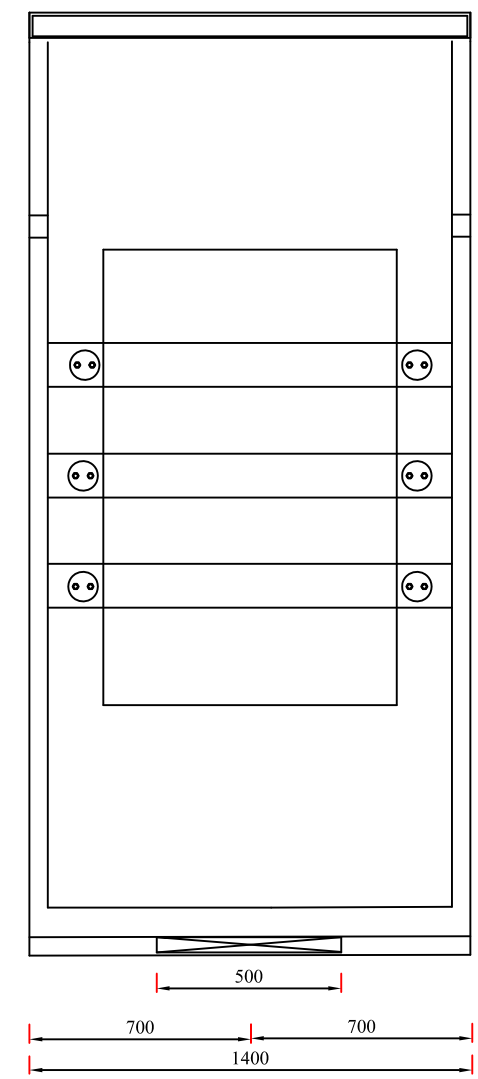

REAR VIEW

NO.	DATE	REVISIONS	PREPARER	CHECKER	REVIEWER	APPROVER
△						
△						
△						

CUSTOMER	
PROJECT	

TITLE	ASSEMBLY LAYOUT FOR LBS & LA PANEL		SCALE	NONE
DWG No.		SHEET No.	DATE	
			CONT.No.	

(주) 호원아이엔씨
 HOWON Instrument & control Co., Ltd.

FROM: KEPCO PAD SWITCH 지중인입선로(L=2138m)
 CABLE: 22.9KV CNCV-W 3-1C/200mmSQ(FEP 150mmDIA)

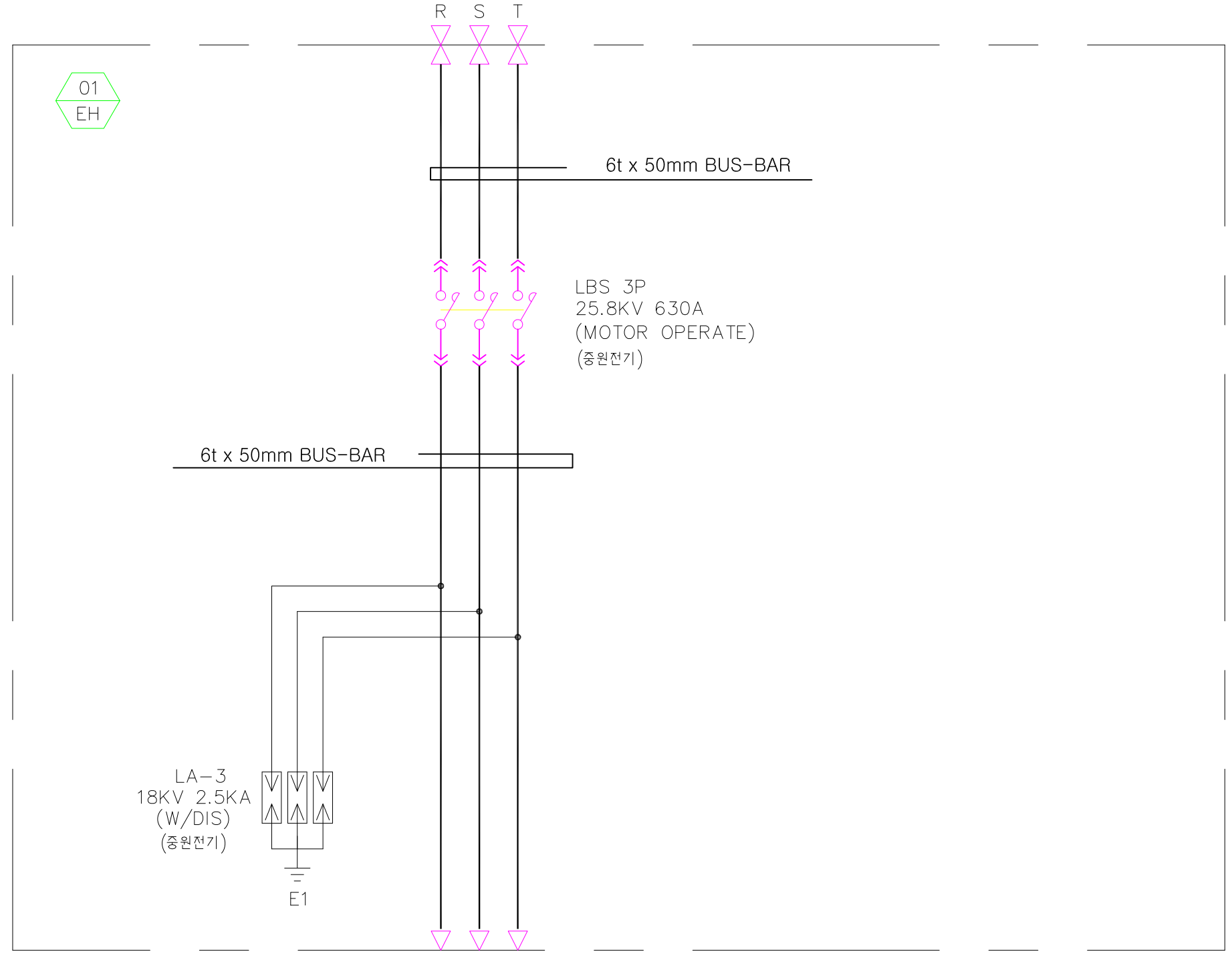

01
EH

6t x 50mm BUS-BAR

LBS 3P
 25.8KV 630A
 (MOTOR OPERATE)
 (중원전기)

6t x 50mm BUS-BAR

LA-3
 18KV 2.5KA
 (W/DIS)
 (중원전기)

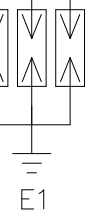

E1

TO: EH-02 PF PANEL

							CUSTOMER				TITLE	SCALE NONE	
							PROJECT				THREE LINE DIAGRAM FOR LBS & LA PANEL		DATE
											DWG No.	SHEET No.	CONT.No.
NO.	DATE	REVISIONS	PREPARER	CHECKER	REVIEWER	APPROVER				(주) 호원아이엔씨 HOWON Instrument & control Co., Ltd.			
1													PAPER : A3(420x297)

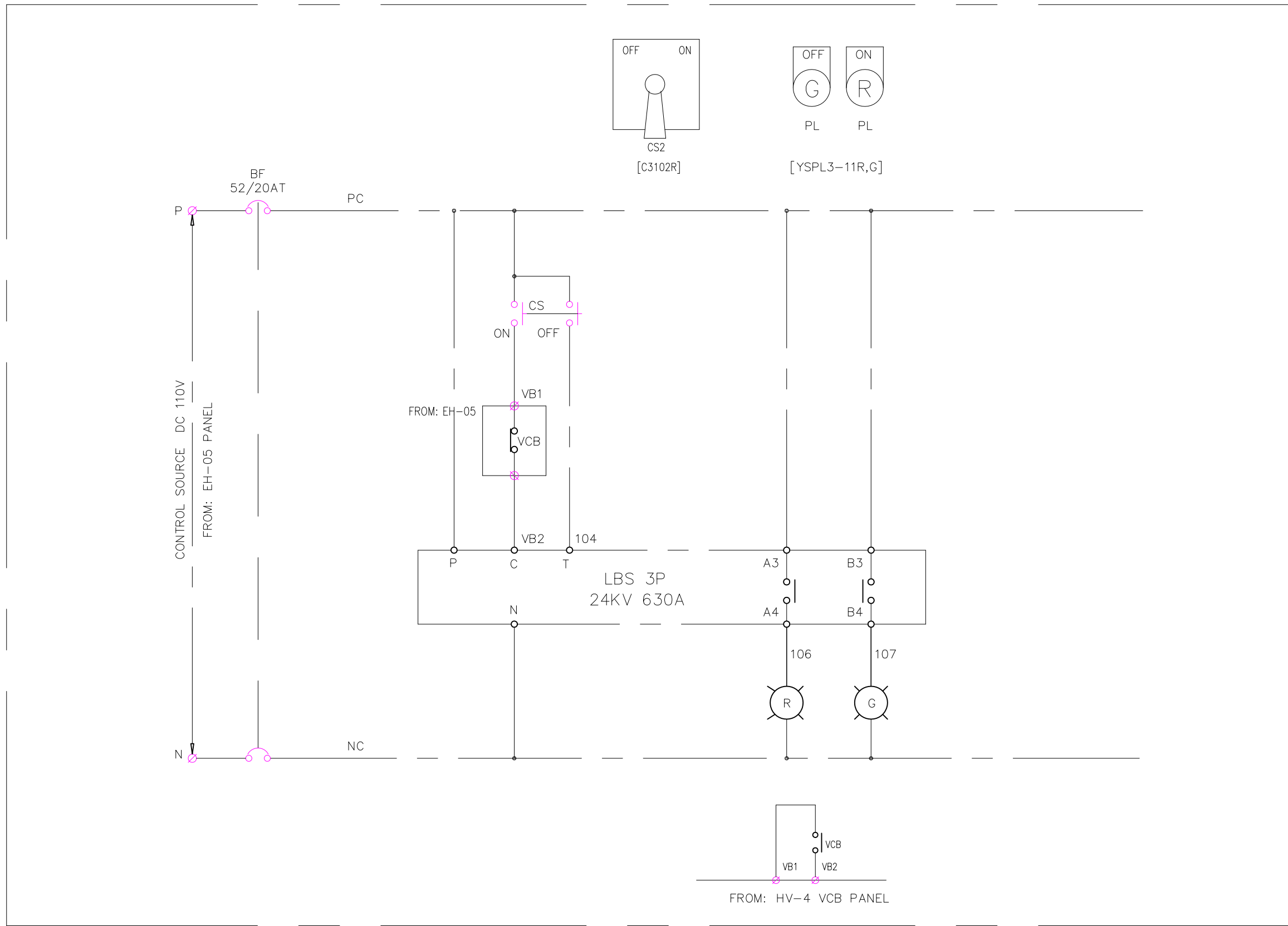

NO.	DATE	REVISIONS	PREPARER	CHECKER	REVIEWER	APPROVER

CUSTOMER
PROJECT

TITLE
SEQUENCE DIAGRAM FOR LBS PANEL

DWG No. SHEET No. CONT.No.

SCALE NONE

DATE

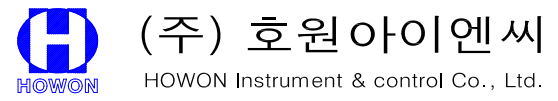

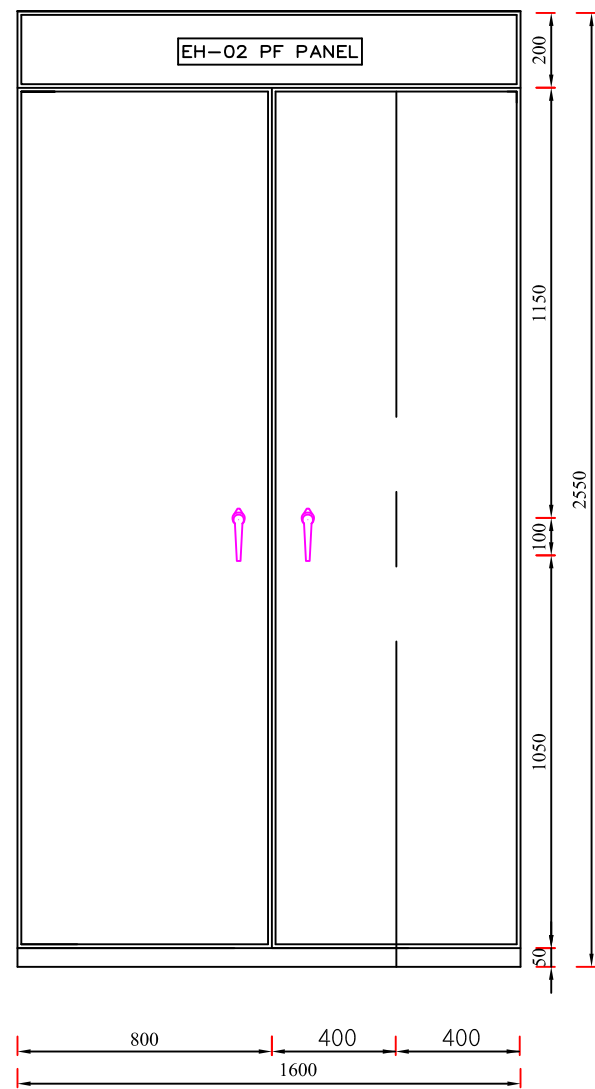

FRONT VIEW

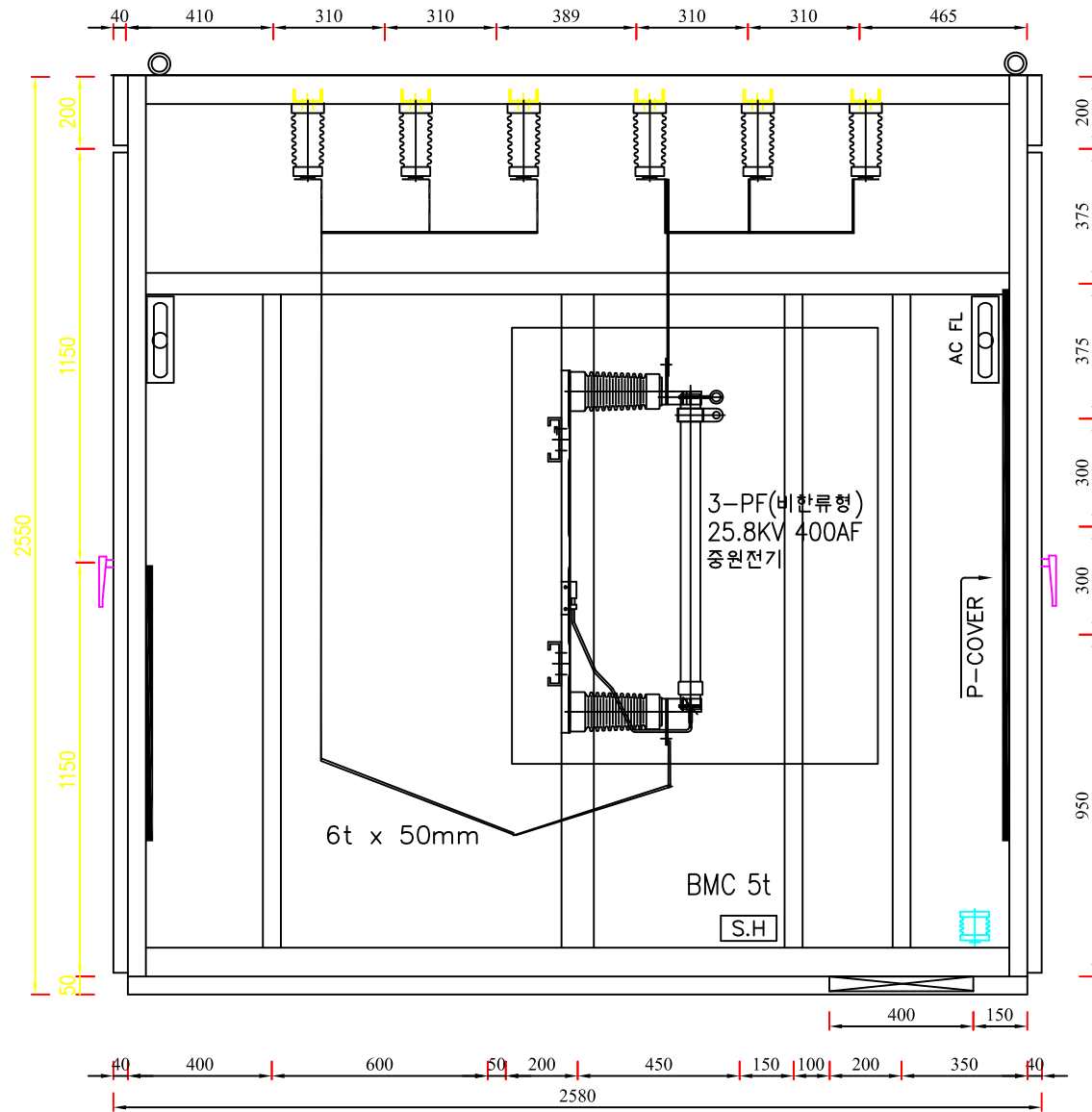

INNER SIDE VIEW

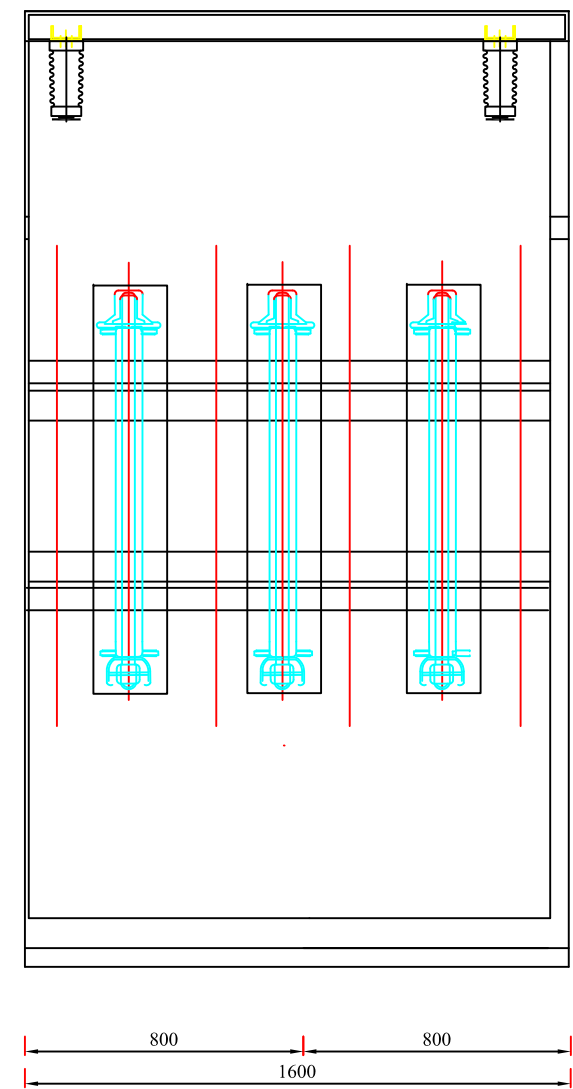

REAR VIEW

				CUSTOMER				TITLE	
								ASSEMBLY LAYOUT FOR PF PANEL	
				PROJECT				DWG No.	
								SHEET No.	
								CONT.No.	
NO.	DATE	REVISIONS	PREPARER	CHECKER	REVIEWER	APPROVER			

				SCALE		NONE	
				DATE			
				PAPER : A3(420x297)		SHEET : A3(405x283)	

HOWON (주) 호원아이엔씨
HOWON Instrument & control Co., Ltd.

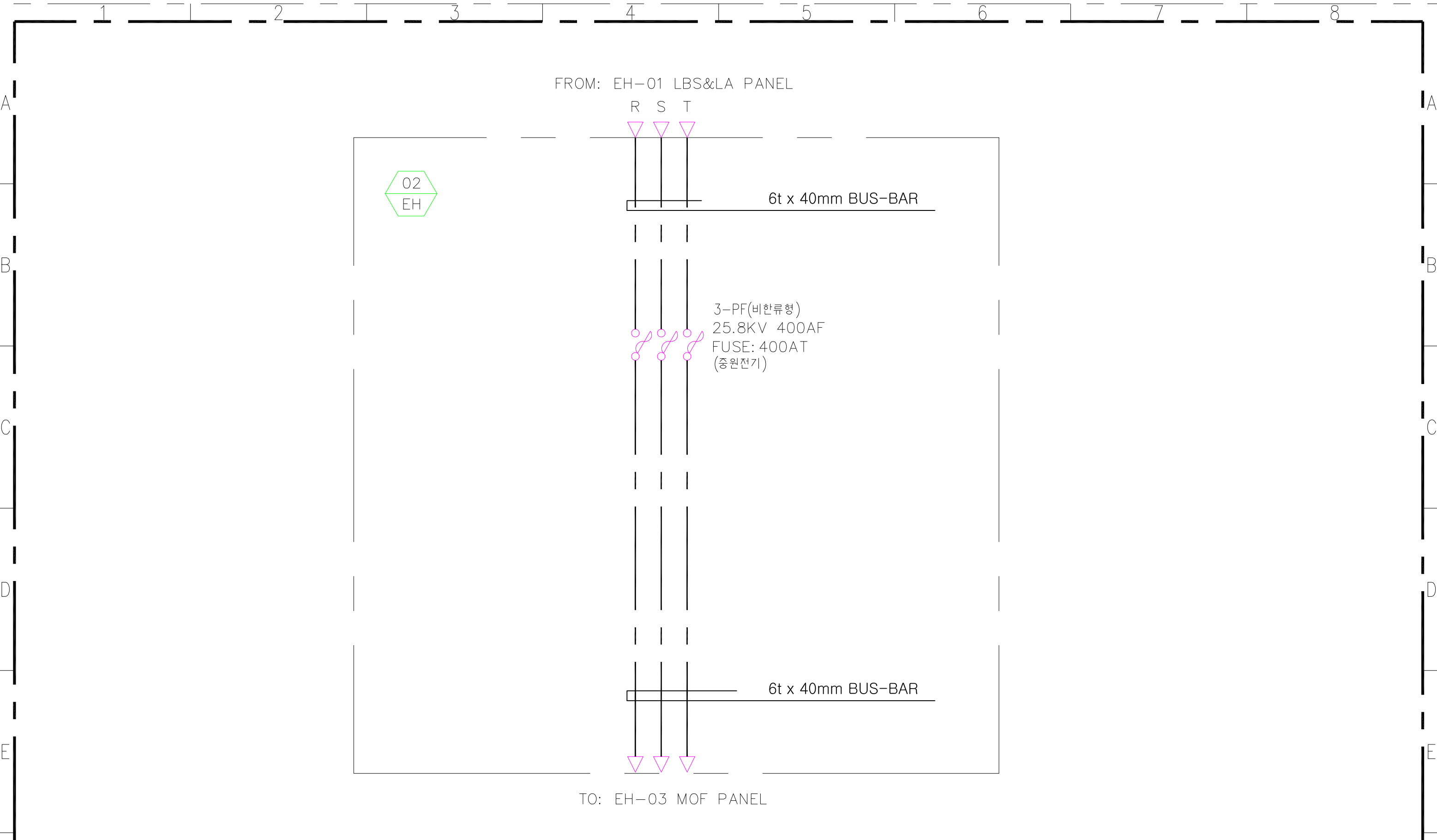

△	NO.	DATE	REVISIONS	PREPARER	CHECKER	REVIEWER	APPROVER	CUSTOMER
								PROJECT

TITLE		THREE LINE DIAGRAM FOR PF PANEL	SCALE	NONE
DWG No.			DATE	
SHEET No.			CONT.No.	

HOWON (주) 호원아이엔씨
HOWON Instrument & control Co., Ltd.

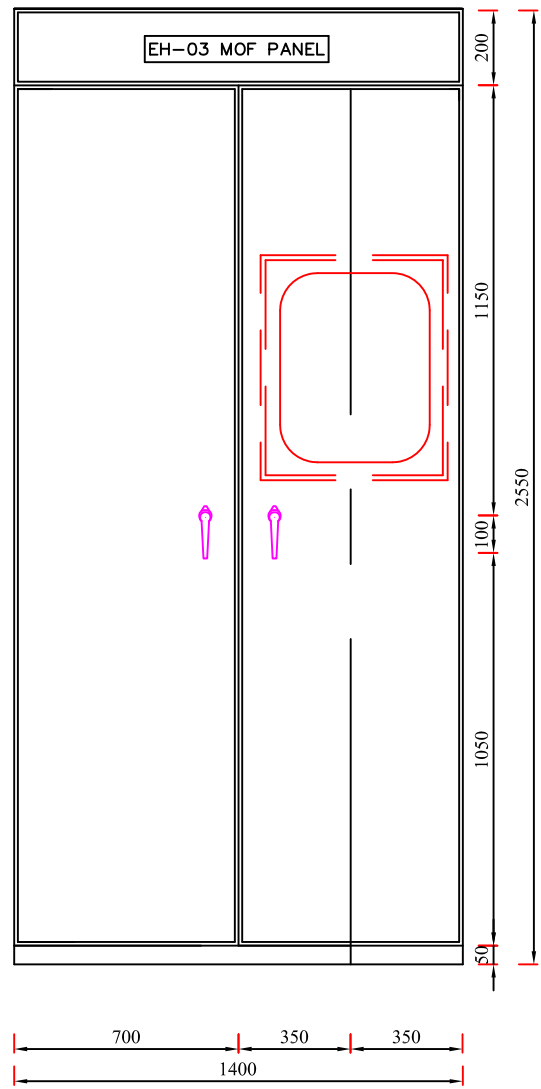

FRONT VIEW

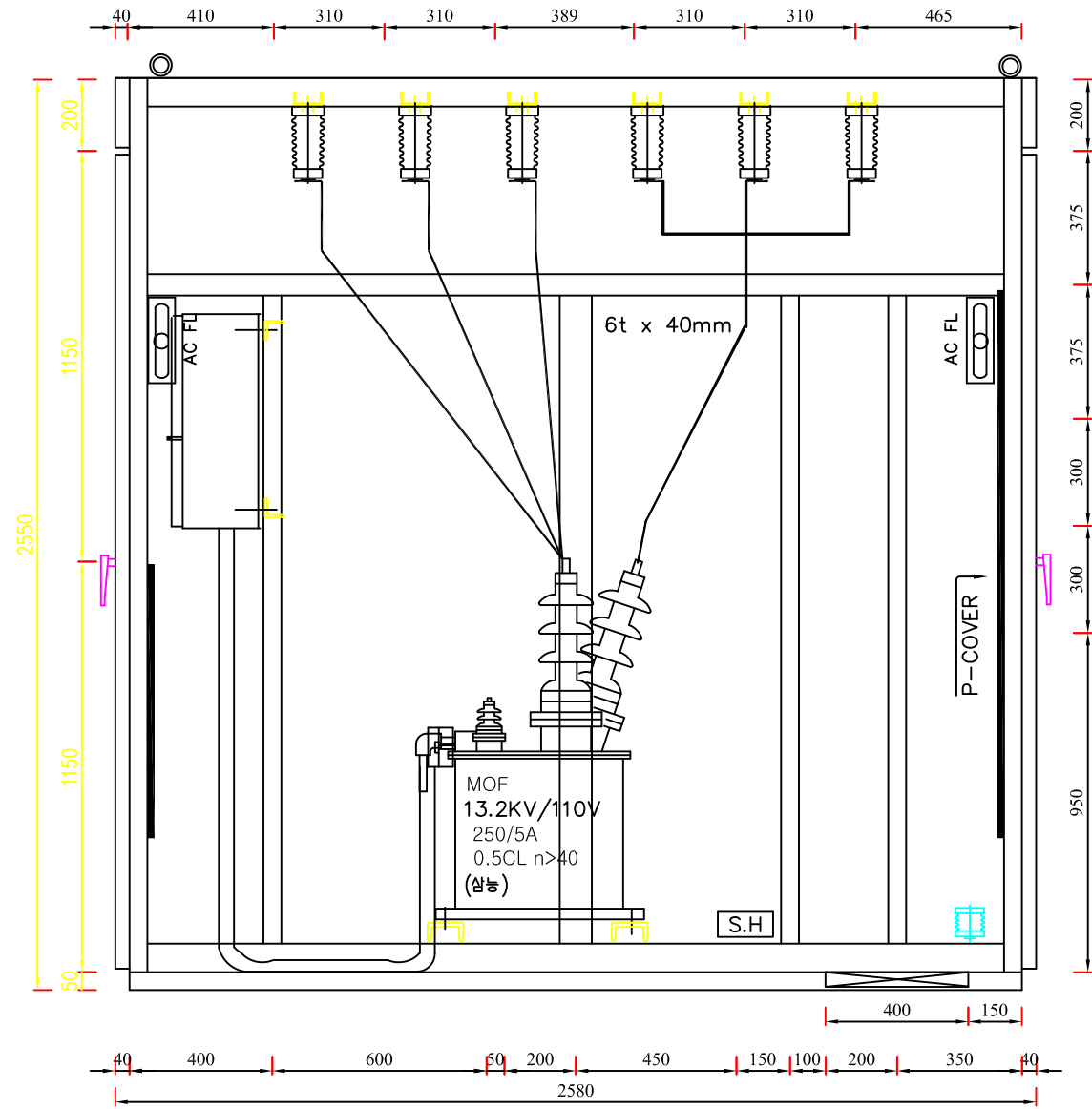

INNER SIDE VIEW

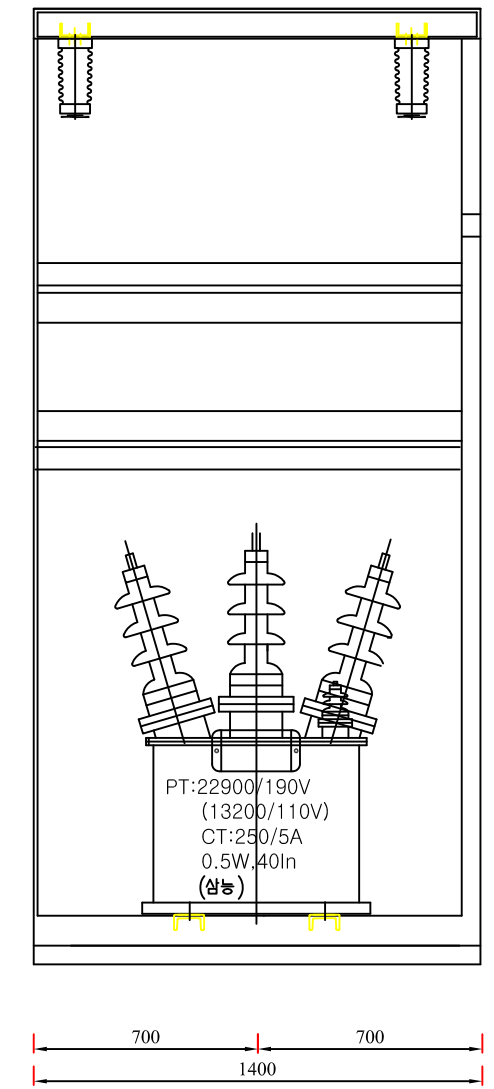

REAR VIEW

				CUSTOMER						TITLE		SCALE NONE	
				PROJECT						ASSEMBLY LAYOUT FOR MOF PANEL		DATE	
										DWG No.		SHEET No.	
												CONT.No.	
NO.	DATE	REVISIONS	PREPARER	CHECKER	REVIEWER	APPROVER							

HOWON (주) 호원아이엔씨
HOWON Instrument & control Co., Ltd.

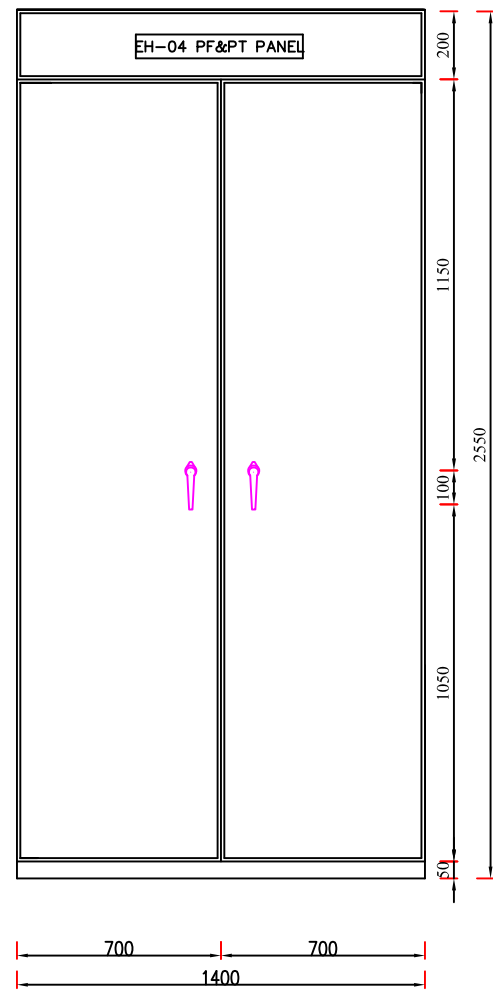

FRONT VIEW

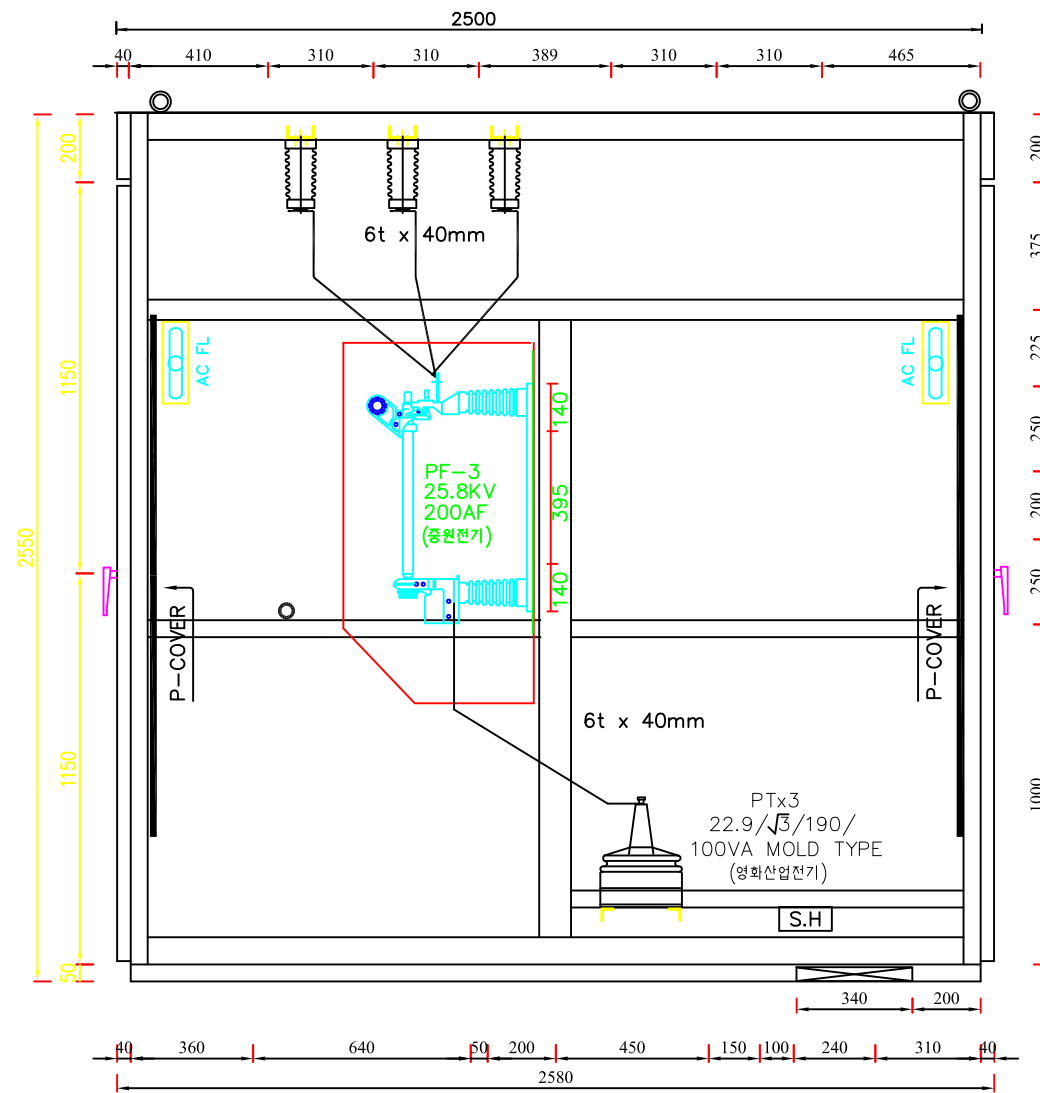

INNER SIDE VIEW

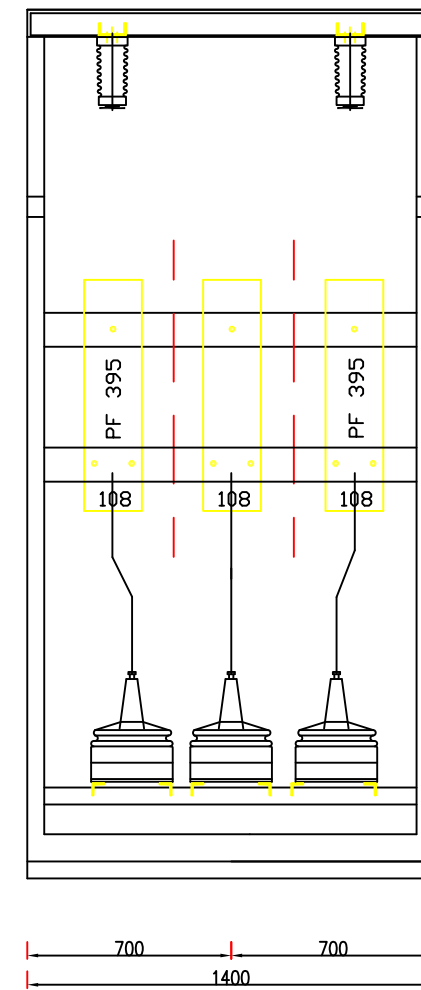

REAR VIEW

△	NO.	DATE	REVISIONS	PREPARER	CHECKER	REVIEWER	APPROVER	CUSTOMER
								PROJECT

TITLE	SCALE
ASSEMBLE LAYOUT FOR PF & PT PANEL	NONE
DWG No.	DATE
SHEET No.	CONT.No.

HOWON (주) 호원아이엔씨
HOWON Instrument & control Co., Ltd.

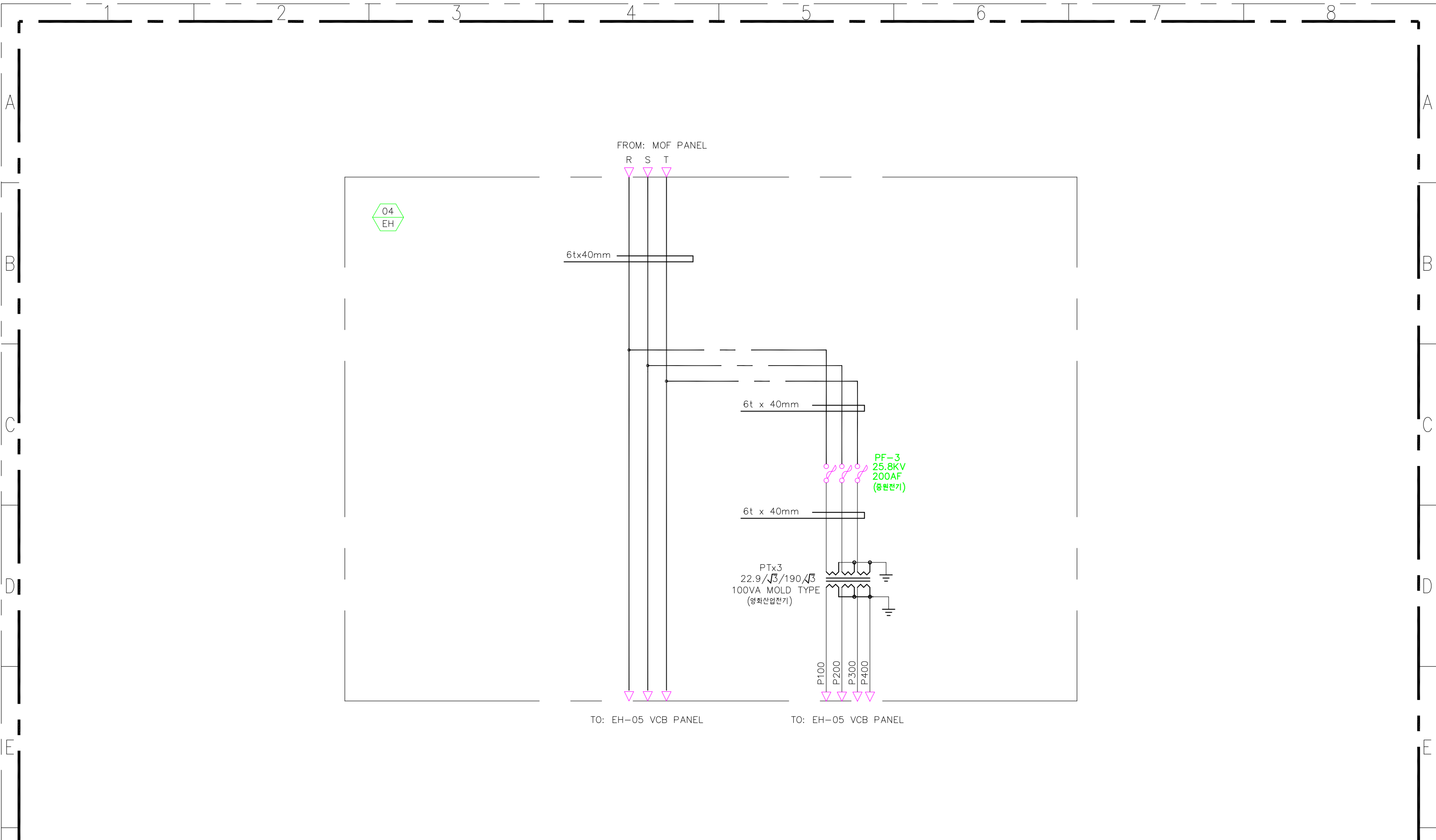

				CUSTOMER			
				PROJECT			
NO.	DATE	REVISIONS	PREPARER	CHECKER	REVIEWER	APPROVER	

TITLE		SCALE
THREE LINE DIAGRAM FOR PF & PT PANEL		NONE
DWG No.	SHEET No.	CONT.No.

(주) 호원아이엔씨
 HOWON Instrument & control Co., Ltd.

PAPER : A3(420x297) SHEET : A3(405x283)

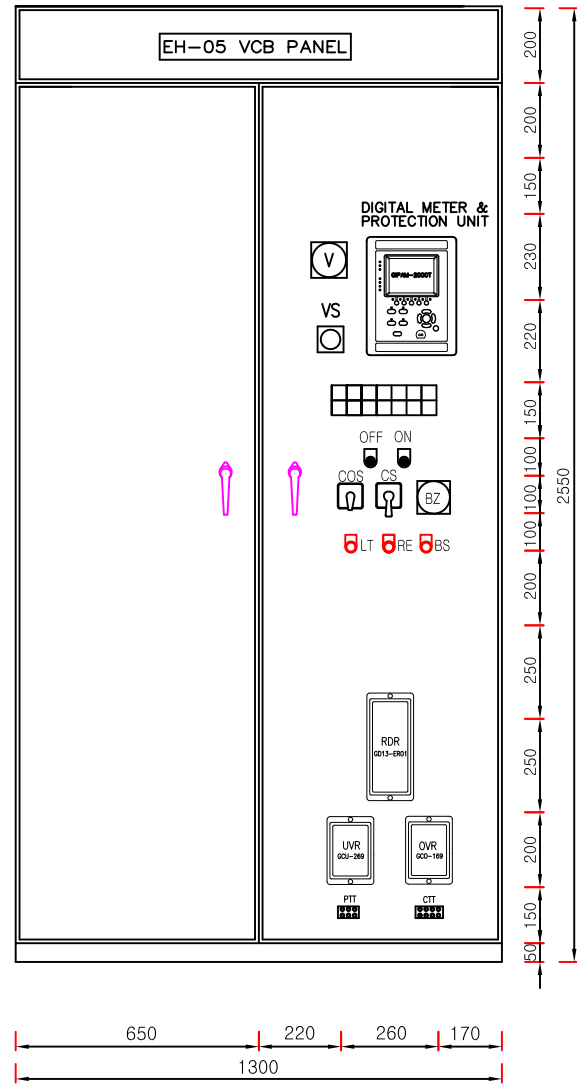

FRONT VIEW

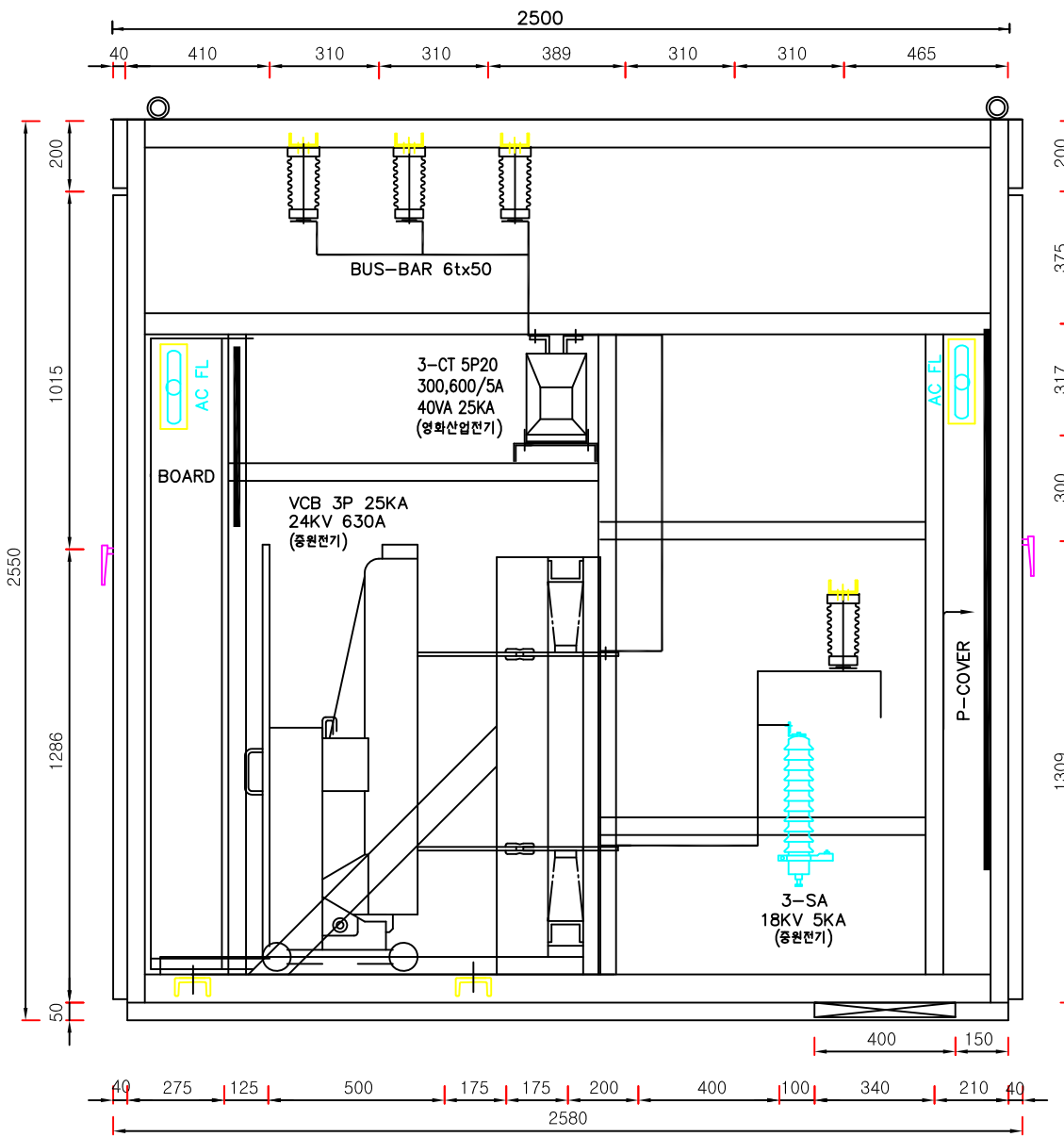

INNER SIDE VIEW

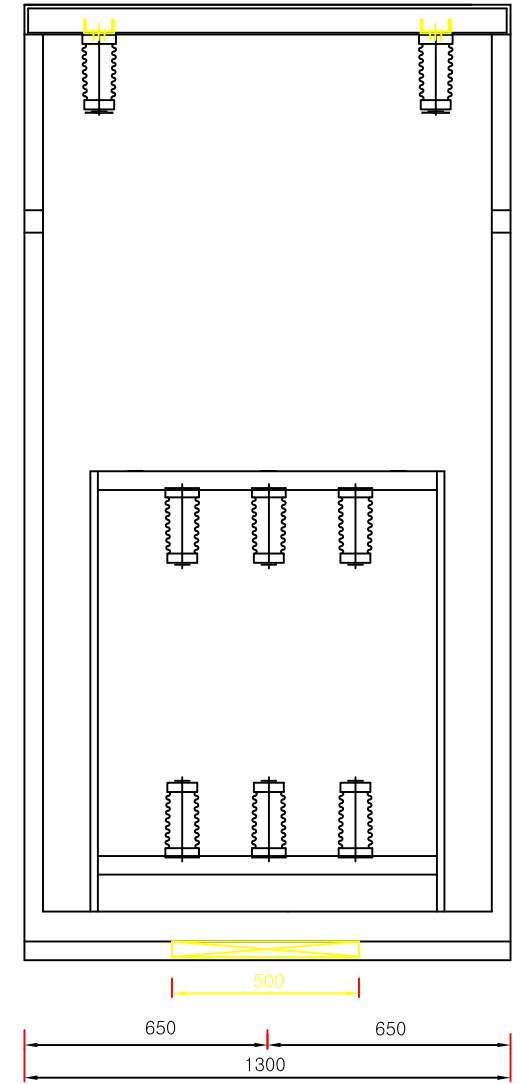

REAR VIEW

NO.	DATE	REVISIONS	PREPARER	CHECKER	REVIEWER	APPROVER
△						
△						
△						

CUSTOMER	
PROJECT	

TITLE	ASSEMBLY LAYOUT FOR VCB PANEL		SCALE	NONE
DWG No.		SHEET No.	DATE	
			CONT.No.	



(주) 호원아이엔씨
HOWON Instrument & control Co., Ltd.

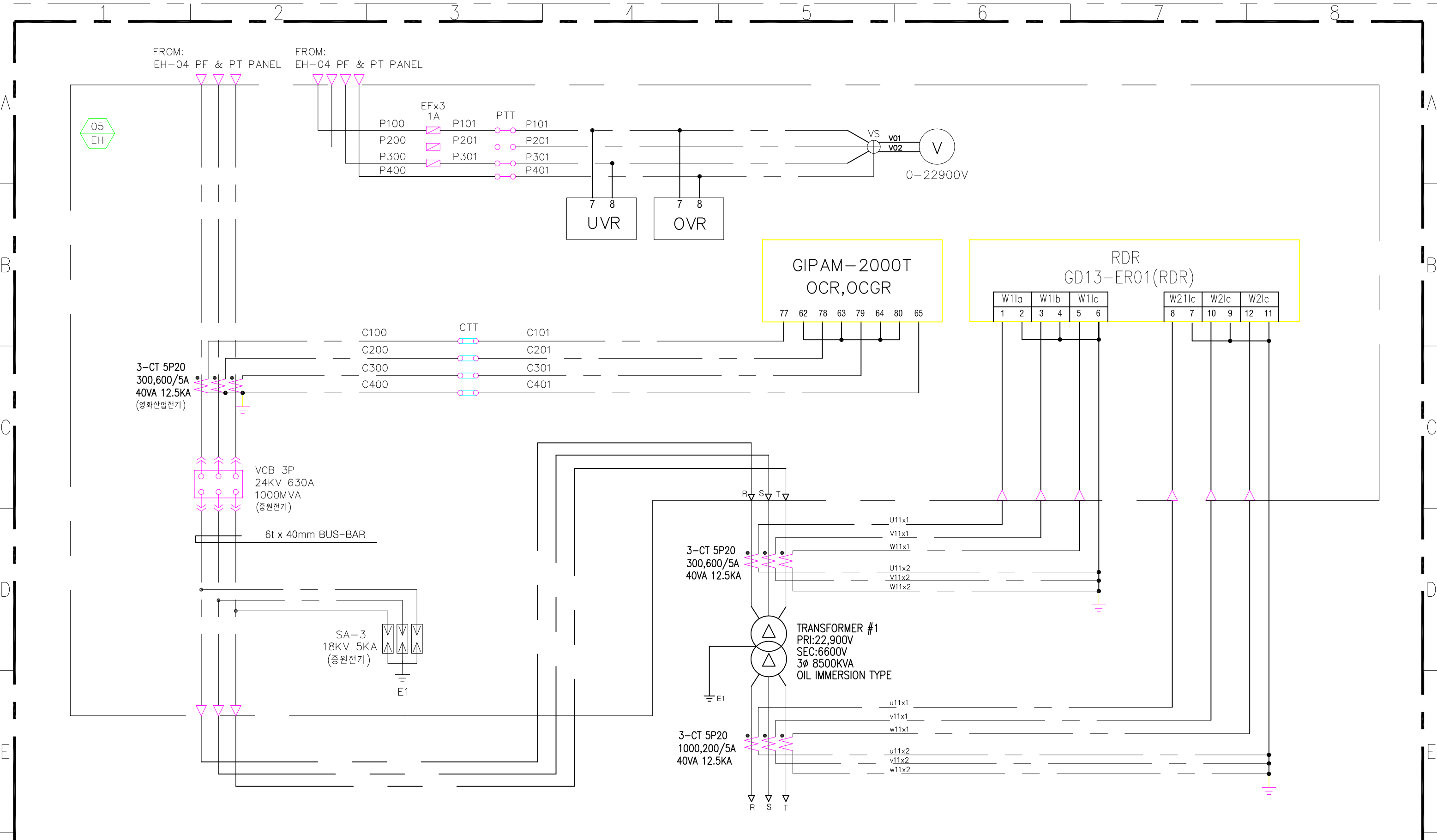

NO.		DATE		REVISIONS		PREPARER		CHECKER		REVIEWER		APPROVER	

CUSTOMER	
PROJECT	

TITLE THREE LINE DIAGRAM FOR VCB PANEL		SCALE NONE
DWG No.	SHEET No.	DATE
		CONT.No.
 (주) 호원아이엔씨 HOWON Instrument & control Co., Ltd.		
PAPER : A3(420x297)		SHEET : A3(405x283)

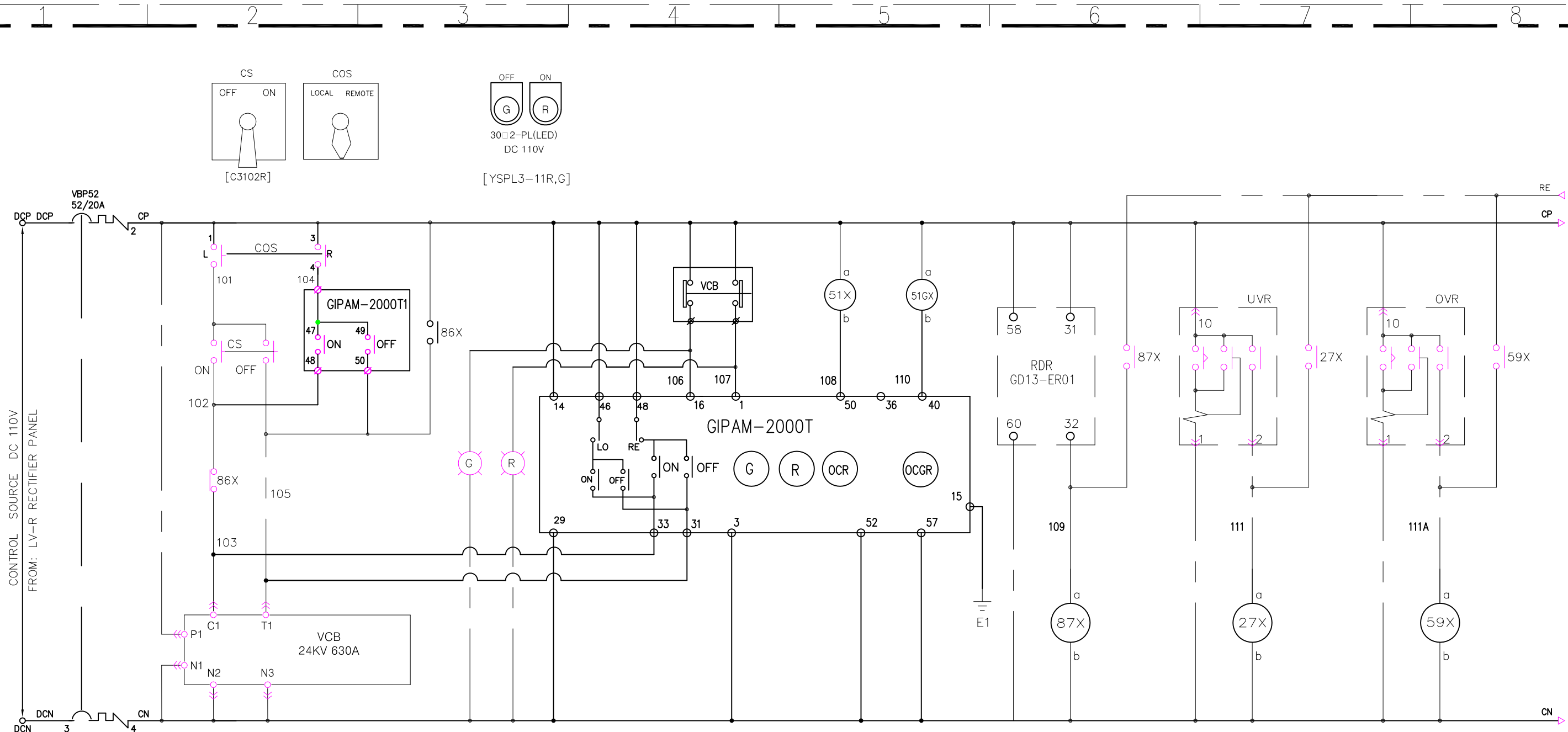

52(VCB)		
a	9 10	8B
b	11 12	8B
a	13 14	20/5D
b	15 16	20/5D
a	17 18	4E
b	19 20	5E
a	21 22	5E
b	23 24	6E
HAF		

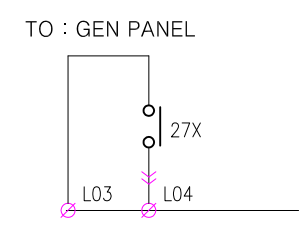
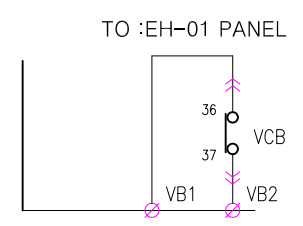

OCR-R 2a 2b		HMT(DC 110V)	
NO CONTACT	NO CONTACT		
1 / 0	13-14 21-22	/	/
2 / 0	43-44 31-32	/	/
2 / 0	53-54 61-62	/	/
1 / 0	73-74		
/	83-84		

RDR 2a 2b		HMT(DC 110V)	
NO CONTACT	NC CONTACT		
1 / 0	13-14 21-22	1 / 0	
2 / 0	43-44 31-32	2 / 0	
1 / 0	53-54 61-62	/	
1 / 0	73-74		
1 / 0	83-84		

OCGR 2a 2b		HMT(DC 110V)	
NO CONTACT	NC CONTACT		
1 / 0	13-14 21-22	/	/
2 / 0	43-44 31-32	/	/
2 / 0	53-54 61-62	/	/
1 / 0	73-74		
/	83-84		

UVR 2a 2b		HMT(DC 110V)	
NO CONTACT	NC CONTACT		
1 / 0	13-14 21-22	/	/
2 / 0	43-44 31-32	/	/
2 / 0	53-54 61-62	/	/
1 / 0	73-74		
/	83-84		

OVR 2a 2b		HMT(DC 110V)	
NO CONTACT	NC CONTACT		
1 / 0	13-14 21-22	/	/
2 / 0	43-44 31-32	/	/
2 / 0	53-54 61-62	/	/
1 / 0	73-74		
/	83-84		

NO.	DATE	REVISIONS	PREPARER	CHECKER	REVIEWER	APPROVER

CUSTOMER	
PROJECT	

TITLE	SEQUENCE DIAGRAM FOR VCB PANEL 1		SCALE	NONE
DWG No.		SHEET No.		DATE
				CONT.No.



(주) 호원아이엔씨
HOWON Instrument & control Co., Ltd.

PAPER : A3(420x297)

SHEET : A3(405x283)

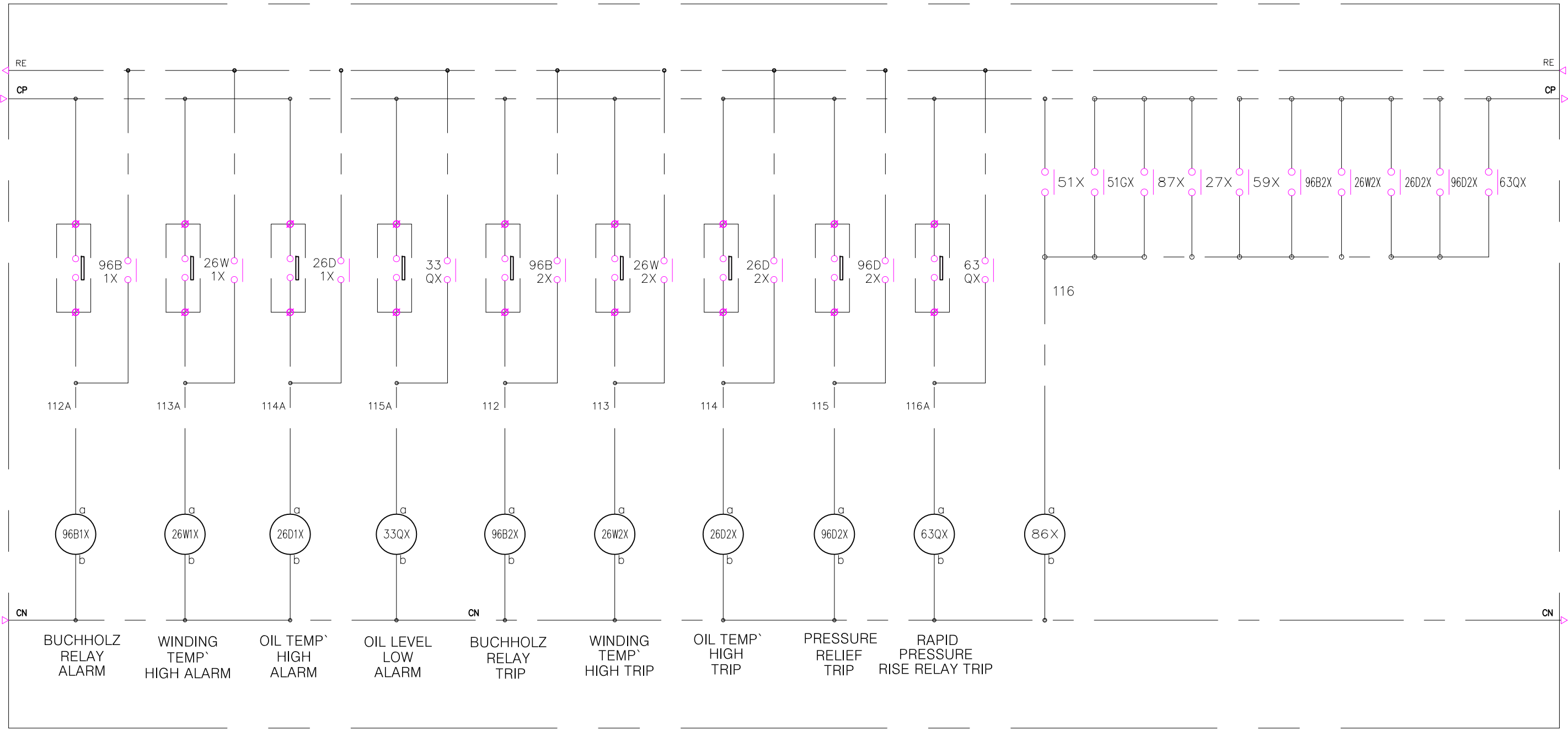

△									
△									
△									
NO.	DATE	REVISIONS	PREPARER	CHECKER	REVIEWER	APPROVER			

CUSTOMER	
PROJECT	

TITLE	SEQUENCE DIAGRAM FOR VCB PANEL 2			SCALE	NONE
DWG No.		SHEET No.		DATE	
				CONT.No.	



(주) 호원아이엔씨
HOWON Instrument & control Co., Ltd.

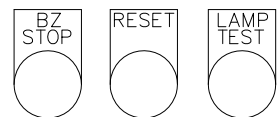

PB-3
[YSP3-11R]

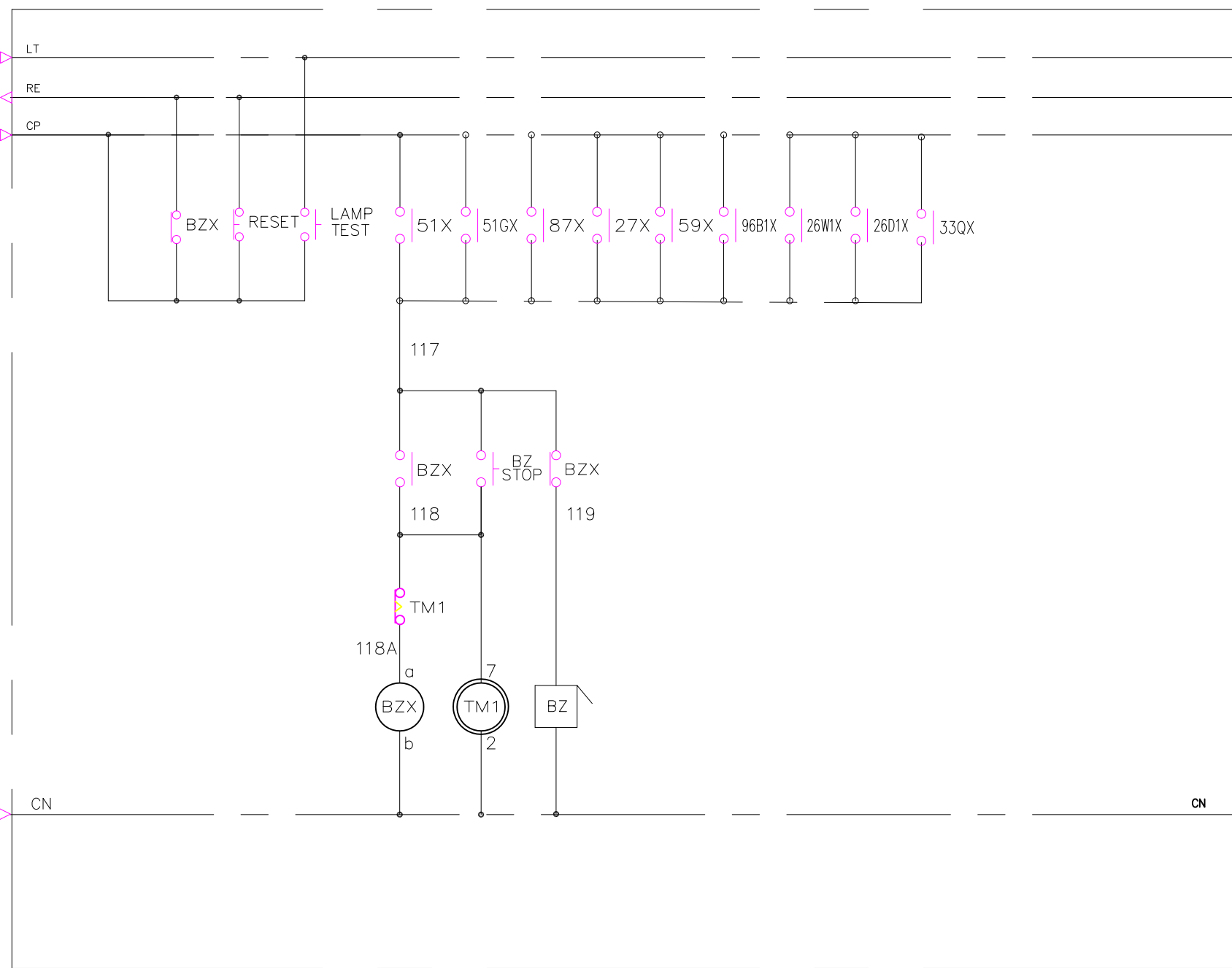

△	NO.	DATE	REVISIONS	PREPARER	CHECKER	REVIEWER	APPROVER	CUSTOMER
								PROJECT

TITLE	SEQUENCE DIAGRAM FOR VCB PANEL 4	SCALE	NONE
DWG No.		DATE	
SHEET No.		CONT.No.	



(주) 호원아이엔씨
HOWON Instrument & control Co., Ltd.